

KLIMA

GEBRUIKERS-HANDLEIDING

ELEKTRISCHE RADIATOR **KLIMA**



DRL
PRODUCTS

WWW.DRL-PRODUCTS.NL

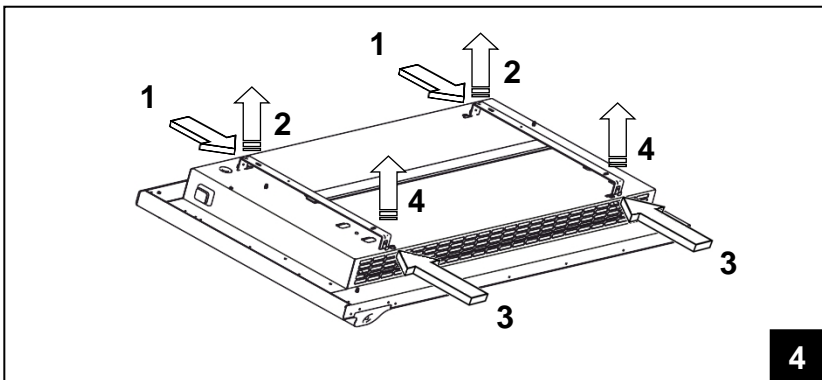
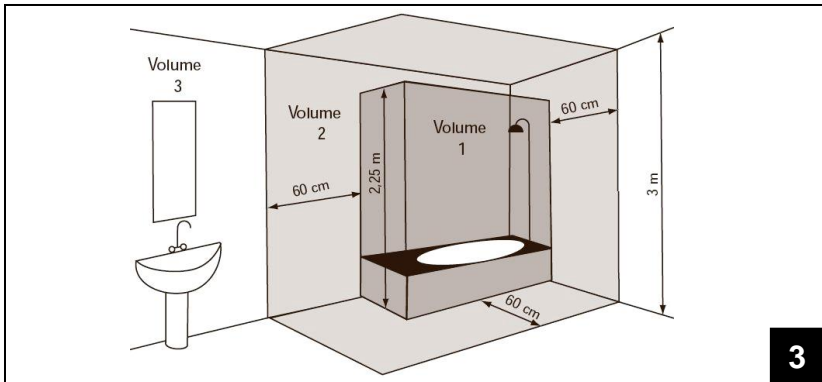
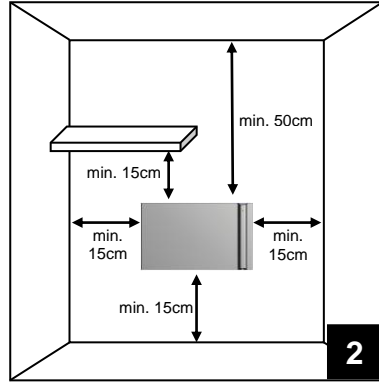
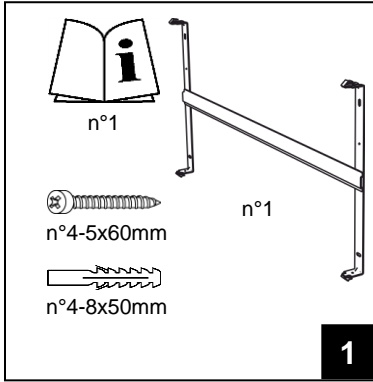

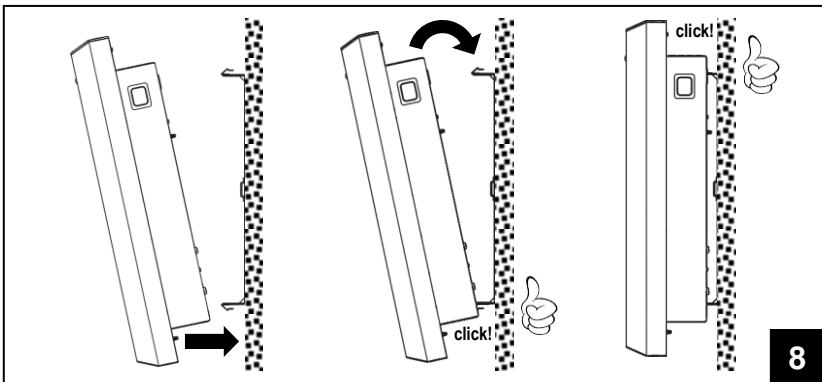
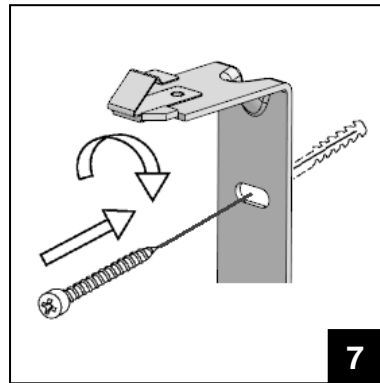
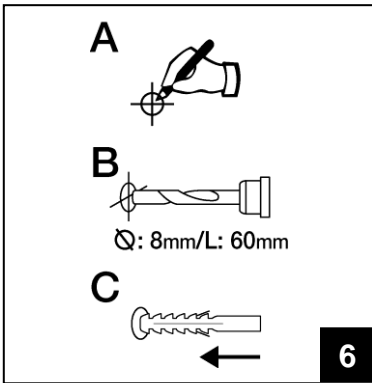
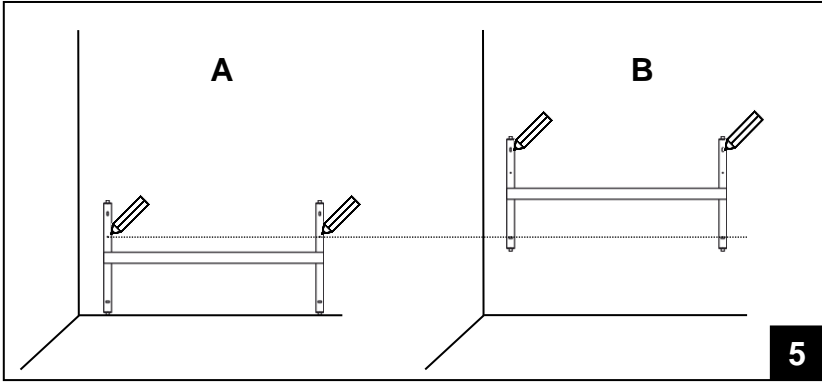

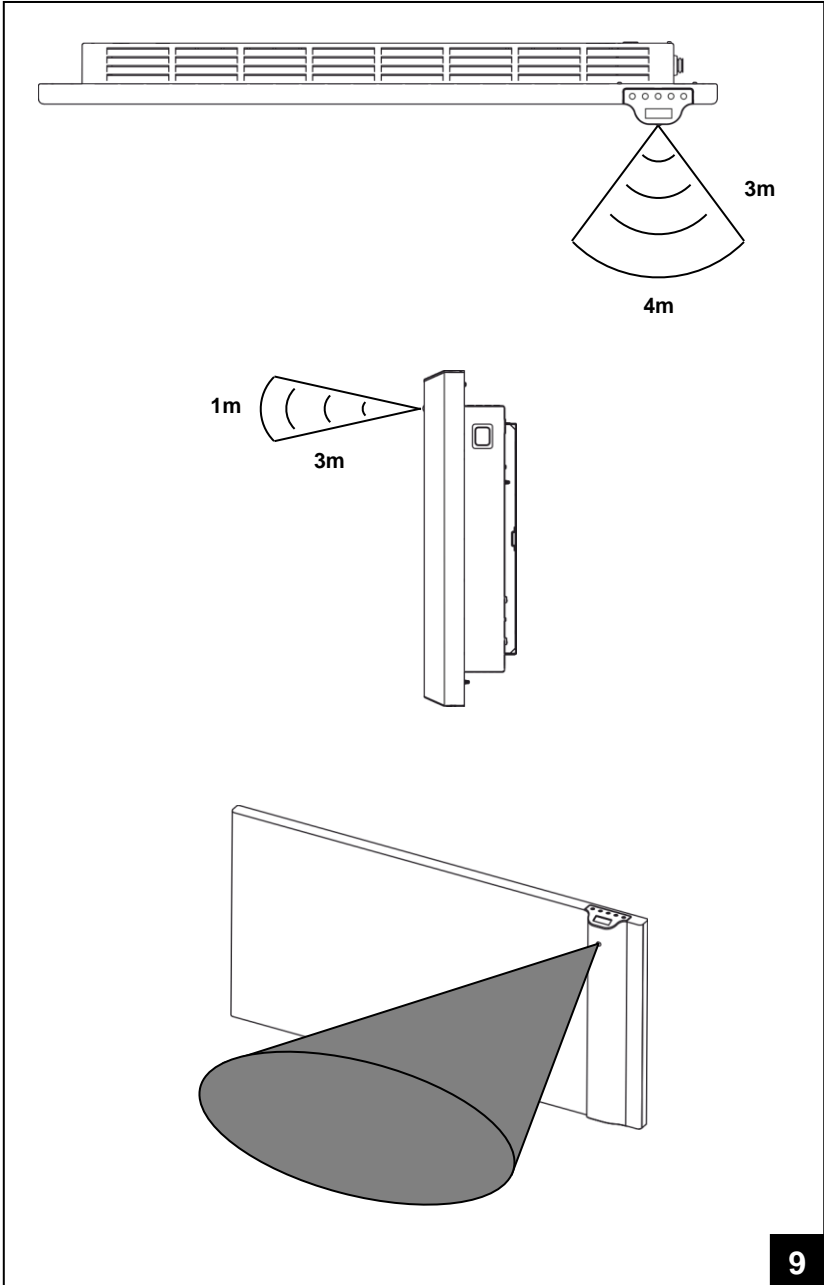

ISTRUZIONI PER L'USO

Si prega di leggere attentamente queste istruzioni, prima di utilizzare il prodotto, in modo da evitare danneggiamenti o comunque il verificarsi di situazioni di pericolo. Qualsiasi utilizzo del prodotto diverso da quanto indicato nel presente manuale può causare incendi, pericoli elettrici o ferite e rende nulla qualsiasi garanzia.

La garanzia non si applica ad alcun difetto, deterioramento, perdita, ferimento o danneggiamento riconducibili ad un uso non corretto del prodotto. Rimangono garantiti tutti i diritti di legge in materia. Nessuna condizione di garanzia può escludere o modificare le condizioni di garanzia regolamentate da leggi dello Stato che non possono essere a nessun titolo escluse o modificate.

Prima di ogni operazione, rimuovere con cura l'imballo e controllare la perfetta integrità del prodotto. Nel caso si evidenziasse dei difetti o danni, non installare né cercare di riparare l'apparecchiatura, ma rivolgersi al rivenditore.

Non lasciare l'imballo alla portata dei bambini e smaltirne le parti in conformità con le disposizioni vigenti.

1. Per la Vostra sicurezza

- ❑ Questo prodotto è per uso domestico e non è adatto per l'utilizzo su veicoli, imbarcazioni o aeromobili.
- ❑ L'apparecchio può essere utilizzato da bambini di età non inferiore a 8 anni e da persone con ridotte capacità fisiche, sensoriali o mentali, o prive di esperienza o della necessaria conoscenza, purché sotto sorveglianza oppure dopo che le stesse abbiano ricevuto istruzioni relative all'uso sicuro dell'apparecchio e alla comprensione dei pericoli ad esso inerenti. I bambini non devono giocare con l'apparecchio. La pulizia e la manutenzione destinata ad essere effettuata dall'utilizzatore non deve essere effettuata da bambini senza sorveglianza.
- ❑ I bambini di età inferiore a 3 anni non devono avvicinarsi al prodotto se non costantemente supervisionati.
- ❑ I bambini di età compresa fra 3 e 8 anni possono solamente accendere e spegnere l'apparecchio purché esso sia stato installato e posizionato secondo le normali condizioni d'uso e loro siano supervisionati o adeguatamente istruiti riguardo al corretto e sicuro utilizzo del prodotto e ne abbiano compresa la pericolosità. I bambini di età compresa fra 3 e 8 anni non possono collegare il prodotto, regolarlo, pulirlo o effettuare manutenzione.
- ❑ **ATTENZIONE: Alcune parti di questo prodotto possono diventare molto calde e causare bruciature. Particolare attenzione deve essere prestata in presenza di bambini o persone vulnerabili.**
- ❑ Assicuratevi che l'alimentazione di rete corrisponda ai dati di targa: 230V AC, 50Hz.

- ❑ Non lasciate mai che animali o bambini giochino o tocchino il prodotto. Attenzione! Durante il funzionamento il pannello può diventare molto caldo (circa 80°C = 176°F);
- ❑ **IMPORTANTE: per evitare surriscaldamenti non ricoprite mai il prodotto.** Non appoggiate mai alcun oggetto o coperta sull'apparecchio mentre è in funzione. Questo è chiaramente scritto sull'apparecchio o illustrato dal simbolo



- ❑ Non utilizzate il prodotto in stanze sature di gas esplosivi, di vapori generati da solventi e vernici o comunque di vapori/gas infiammabili.
- ❑ Se il cavo e/o la spina sono danneggiati e devono essere riparati, non eseguite questa operazione da soli, riportate il prodotto presso il centro di assistenza tecnica, o comunque in un centro di riparazioni qualificato, perché è richiesto l'intervento di personale specializzato al fine di evitare qualunque rischio di danneggiamento.
- ❑ Il prodotto deve essere posizionato in modo tale che la presa di alimentazione sia sempre raggiungibile.
- ❑ Non collocate mai questo apparecchio immediatamente al di sotto di una presa di corrente elettrica.
- ❑ Non inserite nessun oggetto o carta all'interno del radiatore.

2. Il vostro prodotto

- ❑ Il prodotto viene fornito dotato di (figura 1):
 - N°1 staffa metalliche per l'installazione a muro (fissata al radiatore);
 - N°4 tasselli in nylon da 8x50mm;
 - N°4 viti per tasselli da 5x60mm;
- ❑ Qualora il prodotto sia danneggiato o qualche accessorio mancante contattate immediatamente il vostro rivenditore.

3. Posizionamento sicuro

- ❑ Utilizzate il prodotto solo in posizione orizzontale;
- ❑ Il prodotto è costruito in doppio isolamento elettrico (classe II) e, pertanto, non richiede il collegamento di terra;
- ❑ Fate sempre attenzione affinché siano rispettate le distanze minime da pareti, mobili e/o oggetti riportati in figura 2.
- ❑ Non installate mai il prodotto su superfici di legno o di materiale sintetico.
- ❑ Il prodotto ha un grado IP24 di protezione all'acqua. Può pertanto essere utilizzato nei bagni o nei luoghi umidi ma mai installato all'interno del perimetro di vasche o docce (Volume 1 di figura 3).
- ❑ Non installate il prodotto dove vi sono spifferi o correnti d'aria.

4. Installazione

- ❑ Rimuovete la staffa per l'installazione a muro fissata sul posteriore del radiatore facendo scattare prima le 2 molle superiori e successivamente le 2 molle inferiori come illustrato in figura 4.
- ❑ Appoggiate la staffa sul pavimento per utilizzarla come dima per marcare con una matita i punti in cui effettuare i 2 fori di fissaggio inferiori (figura 5A).
- ❑ Sollevate la staffa fino a far coincidere i suoi punti di fissaggio inferiori con le marcature sul muro precedentemente realizzate e marcate con una matita la posizione dei due punti di fissaggio superiore (figura 5B).
- ❑ Realizzate i fori nei 4 punti precedentemente marcati ed inserite i tasselli in plastica (figura 6).
- ❑ Fissate la staffa a muro usando le 4 viti in dotazione (figura 7).
- ❑ Agganciate il prodotto alla staffa iniziando dai 2 punti di fissaggio inferiori e poi facendo scattare in posizione i 2 punti di fissaggio superiori (figura 8).

- ☐ Qualora sia necessario rimuovere il prodotto dalla staffa, si raccomanda di sganciare per primi i due punti di fissaggio inferiori e successivamente quelli superiori.

5. Collegamenti elettrici

- ☐ Il prodotto deve essere alimentato con la tensione di 230V AC 50Hz.
- ☐ Il prodotto può essere fornito dotato di cavo con spina oppure di cavo per l'installazione. Nel caso un prodotto con spina debba essere installato in Francia, il collegamento elettrico con la rete di alimentazione deve essere eseguito tagliando la spina in dotazione e utilizzando una apposita scatola di connessione.
- ☐ Quando il prodotto viene fornito con il cavo per l'installazione senza spina, il collegamento deve essere effettuato usando un cavo a 3 fili (Marrone=Fase, Blu=Neutro, Nero=Filopilota) e una scatola di connessione. **Se non si desidera utilizzare le funzionalità del filo pilota limitarsi al collegamento della fase e del neutro: il prodotto funzionerà correttamente anche senza la presenza del programmatore esterno.**
- ☐ In locali umidi, nei bagni o nelle cucine, il morsetto di collegamento deve essere installato ad almeno 25cm dal pavimento.
- ☐ Il collegamento elettrico con la rete deve inoltre prevedere l'utilizzo di un interruttore bipolare con una distanza minima di apertura fra i contatti di almeno 3mm. Rispettate sempre in modo prioritario le regole di installazione vigenti nel vostro paese.
- ☐ La connessione di terra è vietata. **NON COLLEGATE A TERRA IL FILO PILOTA (NERO).**
- ☐ Se il prodotto deve essere alimentato attraverso un interruttore differenziale da 30mA di sicurezza, accertarsi che anche il filo pilota sia sotto il controllo dell'interruttore differenziale.

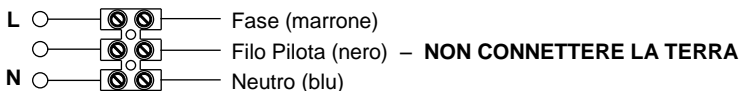

6. Uso del prodotto

6.1 Descrizione dei comandi

- A – Accensione/Stand-by
- B – Modo di funzionamento
- C – Funzioni speciali
- D – Incremento / Attivazione
- E – Decremento / Disattivazione
- F – Display
- G – Interruttore generale

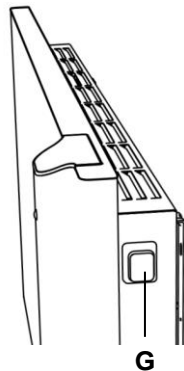
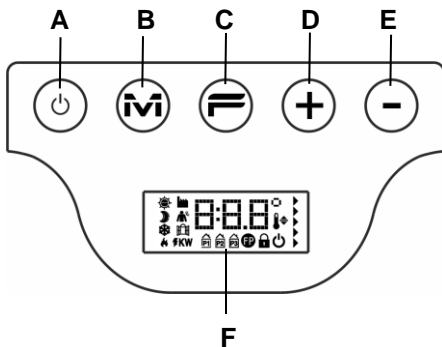

6.2 Funzionamento

6.2.1 Illuminazione dello schermo

Se lo schermo non è acceso premete un qualsiasi tasto per attivarne l'illuminazione. Lo schermo si illumina e rimane acceso per 30 secondi dall'ultima pressione di un qualsiasi tasto.





Quando lo schermo è spento, la prima pressione di un qualsiasi tasto accende l'illuminazione senza attivare la funzione corrispondente al tasto premuto.





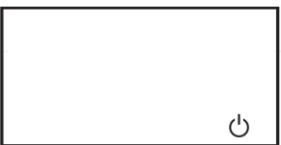
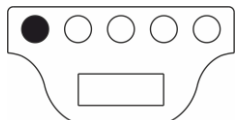

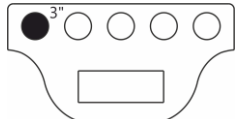
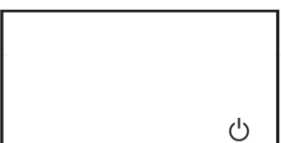
6.2.2 Accendere e spegnere il radiatore

L'alimentazione generale del prodotto è controllata tramite un interruttore elettromeccanico bipolare (G) posto sul lato destro del radiatore. Utilizzando questo interruttore si interrompe l'alimentazione anche alla scheda elettronica con la conseguente perdita, dopo circa 30 minuti, di tutti i parametri memorizzati e il ripristino delle impostazioni di fabbrica.

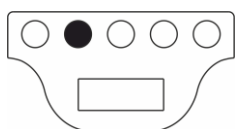

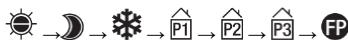



Raccomandiamo di utilizzare questo interruttore solo se il prodotto non verrà utilizzato per lunghi periodi e di usare invece il pulsante di Accensione/Stand-by (A) per gli spegnimenti di breve periodo in modo da non perdere le impostazioni memorizzate.

<p>All'accensione del prodotto con l'interruttore generale posto sul lato, il display si illumina e si accende il simbolo di stand-by.</p>		
<p>Per accendere il prodotto, premere il tasto Accensione/Stand-by.</p> 		<p>Il prodotto si accende sempre in modalità comfort. Se il radiatore è nuovo o l'alimentazione di rete è mancata per più di 30 minuti la temperatura di comfort è quella di default pari a 19°C.</p>
<p>Per spegnere il prodotto, premere il tasto Accensione/Stand-by per almeno 3 secondi.</p> 		<p>Lo spegnimento del prodotto con l'interruttore basculante posto sul lato per oltre 30 minuti causa la perdita di tutti i dati memorizzati (data, ora, temperatura desiderata ecc.).</p>

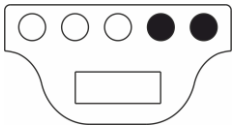

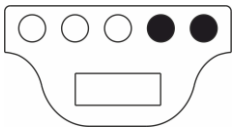
6.2.3 Selezionare il modo di funzionamento



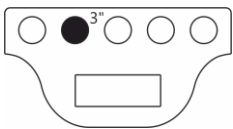
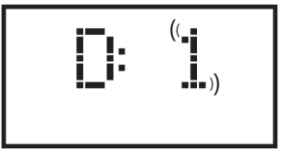
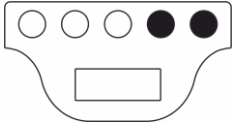
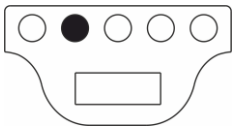

<p>La pressione progressiva del tasto "M" permette di selezionare il modo di funzionamento desiderato.</p> 		<p>I modi di funzionamento si attivano nella seguente sequenza:</p>  <p>Trascorsi 30" dall'ultima pressione del tasto "M", la sequenza di attivazione dei modi di funzionamento riparte dall'inizio in modo da rendere più rapido il passaggio da una qualsiasi modalità a quella Comfort.</p>
Icona	Descrizione	Quando utilizzare
	Comfort	Quando si è a casa. Il prodotto funziona per mantenere la temperatura di comfort desiderata.
	Eco	Quando si è fuori casa per brevi periodi (da 2 a 48 ore) o si dorme. Il prodotto funziona per mantenere la temperatura di eco desiderata e risparmiare energia.
	Antigelo	Quando si è fuori casa per un lungo periodo (oltre le 48 ore). La temperatura è automaticamente impostata a 7±3°C e non può essere modificata.

6.2.4 Regolazione della temperatura

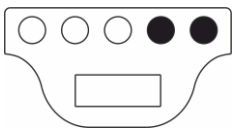
<p>Il prodotto è caratterizzato da 2 temperature di riferimento, comfort ed eco, regolabili in modo indipendente.</p>		<p>Una freccia sul lato destro del display si muove lungo una scala colorata dal verde al rosso per indicare se la temperatura impostata è più o meno distante dal valore consigliato di 19°C.</p>
<p>Il valore predefinito della temperatura di comfort è 19,0°C e può essere variato premendo i tasti "+" o "-".</p> 		<p>Se la temperatura di comfort viene regolata ad un valore inferiore alla temperatura di eco, quest'ultima viene automaticamente reimpostata al valore di comfort - 0,5°C.</p>
<p>Il valore predefinito della temperatura di eco è 15,5°C e può essere variato premendo i tasti "+" o "-".</p> 		<p>La differenza consigliata fra i valori delle temperature di comfort ed eco è di 3,5°C. Qualora si impostino differenze diverse dal valore suggerito, il simbolo eco si modifica nel seguente modo:</p>  <p>Il valore massimo impostabile per la temperatura di eco è pari al valore della temperatura di comfort - 0,5°C.</p>
<p>Se la temperatura ambiente è inferiore alla temperatura richiesta e visualizzata, sul display si accende l'indicatore di riscaldamento .</p>		

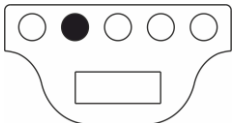
6.2.5 Impostazione del giorno e dell'ora

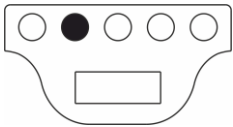
<p>La regolazione del giorno e dell'ora per poter utilizzare i 3 programmi predefiniti è attivabile mediante la pressione prolungata del tasto mode.</p> 		<p>Sul display lampeggia il giorno da impostare (1 = lunedì). Per modificarlo premere i tasti "+" o "-".</p> 
<p>Premere il tasto mode per confermare il giorno impostato e passare alla regolazione dell'ora.</p> 		<p>Sul display lampeggia l'ora da impostare. Per modificarla premere i tasti "+" o "-".</p> 





<p>Premere il tasto mode per confermare l'ora impostata e passare alla regolazione dei minuti.</p> 		<p>Sul display lampeggiano i minuti da impostare. Per modificarli premere i tasti "+" o "-".</p> 
<p>Premere il tasto mode per confermare i minuti impostati e concludere l'operazione di regolazione.</p> 		<p>Il sistema ritorna nel medesimo modo di funzionamento attivo nel momento in cui si è iniziata la regolazione.</p> <p>Provando ad attivare un programma preimpostato, senza aver prima memorizzato la data e l'ora, questa procedura di regolazione verrà attivata automaticamente.</p>

6.2.6 Personalizzazione del programma P1

Il programma P1 può essere modificato per soddisfare al meglio le esigenze dell'utente. La modifica si basa sulla possibilità di impostare, per ogni ora del giorno e per tutti i giorni della settimana in modo indipendente, la temperatura desiderata scegliendo fra quella di comfort, quella di eco o quella di antigelo.

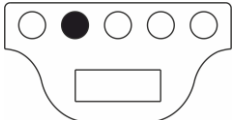
Per la definizione delle temperature associate ai diversi modi di funzionamento fare riferimento al paragrafo 6.2.4.

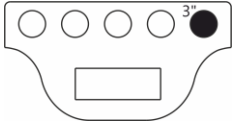
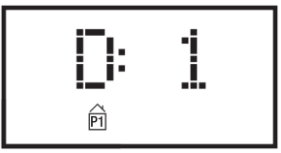
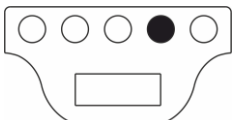
Quando si accede alle diverse ore del giorno per poterle visualizzare e/o modificare, su display viene indicata la temperatura impostata per il programma P1 attualmente valido. Se il prodotto è nuovo il profilo predefinito per il programma P1 è quello indicato al paragrafo 6.2.3.1. Per visualizzare o modificare il programma P1 procedere come segue:

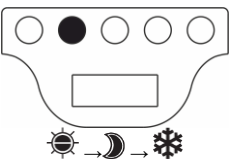
<p>Selezionare il programma P1 utilizzando il tasto "M".</p> 		<p>Qualora l'orario non sia impostato (prodotto nuovo o non alimentato per più di 30min) verrà attivata automaticamente la procedura di regolazione (vedere paragrafo 6.2.5)</p>
<p>Attivare la visualizzazione del programma P1 mediante la pressione prolungata del tasto "+".</p> 		<p>Il display indica il primo giorno da visualizzare/modificare (1 = lunedì)</p>
<p>Premedo una volta il tasto "+" si accede alla prima ora da visualizzare/modificare.</p> 		<p>Usare il tasto "M" per scegliere la temperatura desiderata fra comfort, eco e antigelo:</p>  <p>La temperatura inizialmente visualizzata quando si seleziona un'ora specifica è quella al momento definita per il programma P1 in corso di validità.</p>

Usare i tasti "+" e "-" per accedere a tutte le ore del giorno 1 e visualizzare/modificare la temperatura di funzionamento per ognuna di esse.

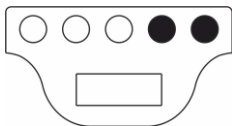

L'ora indicata è sempre quello iniziale. La regolazione delle ore 23, per esempio, riguarda la fascia oraria 23:00 → 24:00.

Dopo aver regolato la temperatura delle ore 23:00 per il giorno 1, un'ulteriore pressione del tasto "+" permette di accedere alla visualizzazione/modifica del giorno 2.

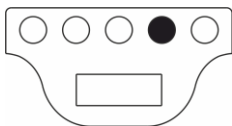

Premendo il tasto "+" è possibile visualizzare/modificare la temperatura di funzionamento per ogni ora del giorno 2 come già descritto per il giorno 1.

Per impostare automaticamente il nuovo giorno uguale a quello precedente tenere premuto il tasto "F" e poi premere il tasto "+".

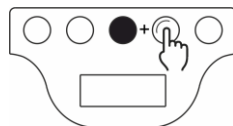

Nota bene: la funzione di copia è disponibile solo quando il display visualizza il numero del giorno che si desidera impostare (non un orario specifico) e rende la programmazione di tale giorno identica a quella del giorno precedente.

Al termine della programmazione dell'ultimo giorno (giorno 7) la pressione del tasto "+" attiva la visualizzazione a display della scritta "END".

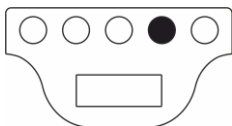

Un' ulteriore pressione del tasto "+" permette di confermare la memorizzazione del programma.

L'indicazione "OK" visualizzata sul display per 5sec conferma l'avvenuta registrazione con successo dei dati impostati.
Il sistema è ora impostato per regolare la temperatura secondo le impostazioni del nuovo programma P1.



Nota: E' anche possibile uscire dalla modalità di programmazione in qualsiasi momento senza dover necessariamente visualizzare tutte le ore fino alla fine del giorno 7. Per farlo è sufficiente tenere premuto il tasto "F" e poi premere il tasto "-".

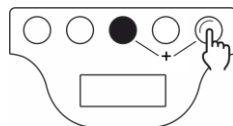









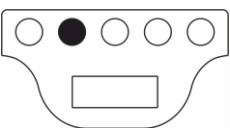

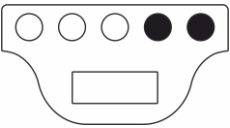

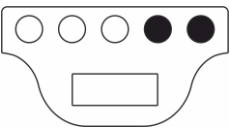

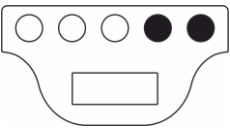

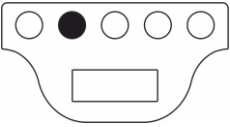

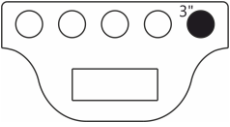

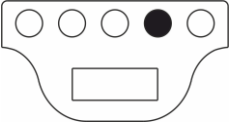

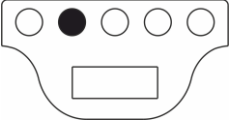

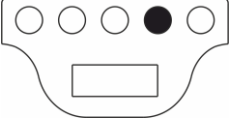

Nota bene:

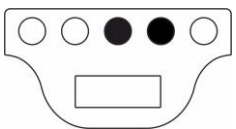
- In ogni momento è possibile abbandonare la procedura di visualizzazione/modifica cancellando le modifiche non ancora salvate premendo il tasto stand-by;
- La funzione di ripristino delle impostazioni di fabbrica (vedere paragrafo 6.3) cancella eventuali programmi P1 personalizzati e ripristina il profilo predefinito;
- In qualsiasi fase della programmazione, la mancata pressione di un qualsiasi tasto per almeno 90sec provoca l'annullamento della procedura di visualizzazione/modifica e il ritorno al programma P1 precedentemente valido ;
- Durante la programmazione gli elementi riscaldanti vengono disattivati ed il radiatore non scalda.

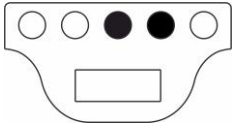

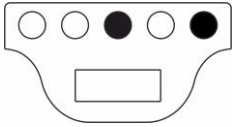

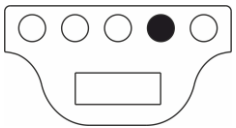
ESEMPIO DI MODIFICA DELLA PROGRAMMAZIONE





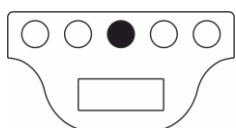

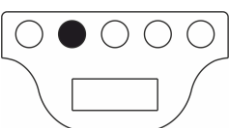
Ipotizziamo di aver appena acquistato il prodotto nuovo e di voler anticipare di un'ora il passaggio dalla temperatura di eco a quella di comfort (prevista dal programma predefinito alle ore 06:00) per tutti i giorni da lunedì a venerdì.

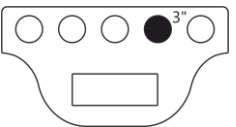

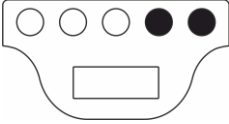
<p>Selezionare il programma P1 utilizzando il tasto "M"</p>		
<p>Impostare il giorno della settimana (poiché abbiamo ipotizzato che il prodotto sia nuovo) usando i tasti "+" e "-"</p>		
<p>Premere il tasto "M" e impostare l'ora corretta (poiché abbiamo ipotizzato che il prodotto sia nuovo) usando i tasti "+" e "-"</p>		
<p>Premere il tasto "M" e impostare i minuti corretti (poiché abbiamo ipotizzato che il prodotto sia nuovo) usando i tasti "+" e "-"</p>		
<p>Premere il tasto "M" per concludere la regolazione dei minuti. Il sistema torna in modalità programmazione con impostato il programma P1.</p>		
<p>Premere per almeno 3sec il tasto "-" per accedere alla visualizzazione/modifica del giorno 1.</p>		
<p>Premere il tasto "+" fino a visualizzare l'ora H:05 che desideriamo modificare cambiando la temperatura da eco a comfort</p>		
<p>Premere il tasto "M" 2 volte per cambiare la temperatura da eco a comfort</p>		
<p>Premere il tasto "+" fino a visualizzare sul display la scritta D: 2 rappresentativa dell'inizio della programmazione giorno 2</p>		

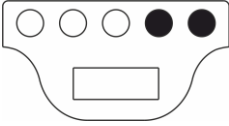
<p>Rendere il giorno 2 identico al giorno 1 tenendo premuto il tasto "F" e poi premendo il tasto "+". Il sistema si porta automaticamente all'inizio del giorno 3.</p>		
<p>Eseguire l'operazione di cui al punto precedente fino a rendere il giorno 5 uguale al giorno 4. Al termine il sistema si porta all'inizio del giorno 6.</p>		
<p>Dal momento che non si desidera modificare i giorni 6 e 7 è possibile uscire dalla modalità di programmazione tenendo premuto il tasto "F" e poi premendo il tasto "-". Sul display compare la scritta END.</p>		
<p>Premere il tasto "+" per ultimare la procedura. Sul display compare per 5" la scritta OK.</p>		

6.3 Funzioni speciali

<p>La pressione progressiva del tasto "F" permette di selezionare in sequenza le varie funzioni speciali disponibili.</p> 		<p>L'uscita dal menù delle funzioni speciali può essere ottenuta semplicemente attendendo 12 secondi, oppure premendo il tasto "M" per tornare alla visualizzazione del modo di funzionamento.</p> 
<p>Ripristino delle impostazioni di fabbrica.</p>		<p>Per reimpostare tutti i parametri del radiatore alle condizioni iniziali definite dal costruttore premere per almeno 3sec il tasto "+".</p> 

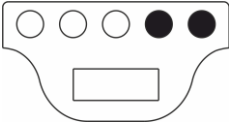
<p>Sensore di presenza</p> <p>Grazie a questa funzione, il radiatore è in grado di identificare la presenza o meno di persone nel locale e regolare automaticamente il livello di riscaldamento per ottimizzare il comfort ed il risparmio energetico.</p> <p>Per maggiori dettagli fare riferimento al paragrafo 6.3.1.</p>		<p>L'attivazione (ON) o la disattivazione (OFF) della funzione si ottengono premendo rispettivamente i tasti "+" o "-"</p>  <p>L'attivazione è indicata dalla relativa icona che si accende sul display </p>
<p>Sensore finestra aperta</p> <p>Questa funzione permette di identificare l'apertura di una finestra e di impostare automaticamente il modo di funzionamento antigelo.</p> <p>Per maggiori dettagli fare riferimento al paragrafo 6.3.2.</p>		<p>L'attivazione (ON) o la disattivazione (OFF) della funzione si ottengono premendo rispettivamente i tasti "+" o "-"</p>  <p>L'attivazione è indicata dalla relativa icona che si accende sul display </p>
<p>Consumo giornaliero</p> <p>Questa funzione permette di visualizzare il consumo del radiatore nelle 24 ore precedenti.</p>		<p>Se l'indicazione del consumo lampeggia significa che i dati memorizzati sono relativi ad un periodo di tempo inferiore alle 24 ore.</p> <p>Nota bene: il display visualizza un consumo stimato che può differire da quello misurato con strumenti specifici adeguati a tale scopo.</p>
<p>Consumo settimanale</p> <p>Questa funzione permette di visualizzare il consumo del radiatore nei 7 giorni precedenti.</p>		<p>Se l'indicazione del consumo lampeggia significa che i dati memorizzati sono relativi ad un periodo di tempo inferiore ai 7 giorni.</p> <p>Nota bene: il display visualizza un consumo stimato che può differire da quello misurato con strumenti specifici adeguati a tale scopo</p>
<p>Visualizzazione della temperatura ambiente</p>		<p>Viene visualizzata sul display la temperatura ambiente misurata dal radiatore.</p>

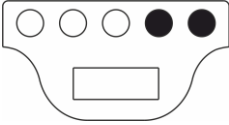
<p>Allineamento della temperatura ambiente</p> <p>Questa funzione permette di modificare la temperatura ambiente misurata dal radiatore ed utilizzata per gestire la potenza riscaldante, qualora essa necessiti di essere corretta per compensare errori di lettura dovuti, per esempio, alla vicinanza con altre fonti di calore o alla presenza di spifferi di aria fredda.</p>		<p>Sul display lampeggia il valore di correzione da applicare. Per modificarlo premere i tasti "+" o "-".</p>  <p>Se ad esempio, la temperatura impostata sul radiatore è 19,2°C e nell'ambiente si misurano 19,5°C effettuare un allineamento pari a +0,3°C.</p>  <p>Attendere sempre almeno 4 ore per far stabilizzare le temperature prima di eseguire un eventuale allineamento.</p>
<p>Controllo remoto</p> <p>Questa funzione permette di controllare il radiatore usando timer esterni, prese pilotate con controllo telefonico e dispositivi simili.</p> <p>Per maggiori dettagli fare riferimento al paragrafo 6.3.3.</p>		<p>L'attivazione (ON) o la disattivazione (OFF) della funzione si ottengono premendo rispettivamente i tasti "+" o "-".</p>  <p>Attenzione: l'attivazione NON è indicata da nessuna icona sul display.</p>

6.3.1 Sensore di presenza

Grazie a questa funzione, il radiatore è in grado di identificare la presenza o meno di persone nel locale e regolare automaticamente il livello di riscaldamento per ottimizzare il comfort ed il risparmio energetico.

Grazie a questa funzione, attivabile esclusivamente in modalità Comfort, il prodotto esegue un monitoraggio continuo della stanza e, qualora non rilevi la presenza di persone, riduce la temperatura di comfort impostata nel seguente modo:

Periodo di assenza	Riduzione della temperatura di comfort	Indicazione sul display
60 min	1,0°C	I simboli del sensore di presenza e della modalità comfort lampeggiano contemporaneamente 
90 min	2,0°C	
120 min	3,5°C	
38 ore	Attivazione Antigelo 7±3°C	

La riduzione della temperatura di riferimento è sempre riferita alla temperatura di comfort. Se il prodotto si trova in modalità Eco o Antigelo, non si osserverà nessuna variazione della temperatura da mantenere nel locale.

Qualora venga rilevata nuovamente la presenza nel locale per almeno 10 minuti consecutivi, la temperatura di riferimento verrà automaticamente impostata uguale alla temperatura di comfort senza nessuna riduzione. Lo stesso avviene se durante il periodo di riduzione della temperatura desiderata, dovuto all'assenza di persone nel locale, viene premuto il tasto "M".

Importante:

Il corretto funzionamento di questa funzione può dipendere dal posizionamento del prodotto nel locale. Per scegliere la migliore posizione per l'installazione tenete presente che il sensore rileva i movimenti all'interno dell'area indicata in figura 9 e che non devono esserci oggetti che possano interferire. Il rilevamento della presenza inoltre è più efficace quando le persone si muovono davanti al sensore rispetto a quando si muovono verso di esso.

6.3.2 Sensore finestra aperta

Questa funzione permette di identificare l'apertura di una finestra e di impostare automaticamente il modo di funzionamento Antigelo.

Qualora venga rilevata una brusca riduzione della temperatura durante il normale funzionamento del prodotto, viene attivata automaticamente la modalità antigelo per ridurre lo spreco di energia. Sul display lampeggiano insieme il simbolo della finestra e dell'antigelo mentre il simbolo del modo di funzionamento impostato dall'utente rimane acceso fisso.



Il ripristino del normale funzionamento non è automatico ma si ottiene premendo il tasto "M".

Importante:

Il corretto funzionamento di questa funzione può dipendere dal posizionamento del prodotto del locale, dalla presenza di spifferi, dalla temperatura esterna e dal tempo di apertura della finestra.

6.3.3 Controllo remoto

Questa funzione permette di controllare il radiatore usando timer esterni, prese pilotate con controllo telefonico e dispositivi simili. Quando la funzione è attivata, nel caso il prodotto venga alimentato dopo una interruzione della tensione di rete superiore ai 30 minuti, al momento dell'accensione non viene impostata la modalità Standby, come avviene normalmente, ma direttamente la modalità di Comfort. La temperatura di comfort è quella impostata prima dell'interruzione dell'alimentazione. Il sensore di presenza (opzionale) e quello di finestra aperta vengono disattivati. In questo modo è possibile accendere direttamente il radiatore senza essere presenti nel locale.

6.4 Utilità

Blocco comandi

E' possibile bloccare i comandi del radiatore per evitare che le regolazioni possano essere modificate accidentalmente o da persone non autorizzate.

Per entrare nella modalità di blocco/sblocco tenere premuto il pulsante "F".

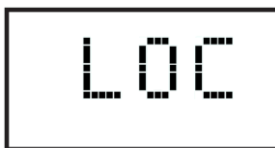
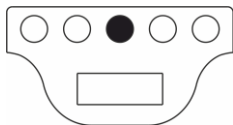

Dopo aver visualizzato la scritta "LOC" sul display:

Tenere premuto il tasto "F" e premere contemporaneamente il tasto "+" se si desidera bloccare i controlli:



L'attivazione è indicata dalla relativa icona che si accende sul display 

Tenere premuto il tasto "F" e premere contemporaneamente il tasto "-" se si desidera sbloccare i controlli:

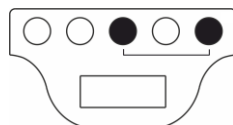

Quando la funzione è attivata, nel caso il prodotto venga alimentato dopo una interruzione della tensione di rete superiore ai 30 minuti, si ha il ripristino dello stato attivo al momento dell'interruzione di tensione. Qualora fosse stato attivo uno dei programmi P1, P2 o P3 viene invece attivato lo stato "antigelo" poiché è necessario reimpostare l'orario e il giorno della settimana prima di attivare nuovamente un programma.

7. Risoluzione dei problemi

Problema	Soluzione
Il radiatore non si accende.	Verificare che vi sia l'alimentazione di rete, che essa corrisponda ai dati di targa del prodotto (es. 230Vac 50Hz) e che l'interruttore generale posto sul lato destro del radiatore sia acceso (posizione "I").
Il radiatore non scalda.	Assicuratevi che il modo di funzionamento impostato sia quello che desiderate e, se state usando un programma predefinito, di non essere in una fascia oraria che preveda il funzionamento in Antigelo. Se la temperatura dell'ambiente è superiore a quella impostata è corretto che il radiatore non scaldi. In caso di dubbi, impostate la modalità Comfort ed una temperatura desiderata molto maggiore della temperatura ambiente per verificare il corretto funzionamento del radiatore.
Il radiatore scalda sempre.	Verificate che non sia stata impostata una temperatura desiderata troppo elevata o che non vi siano correnti d'aria che investono il prodotto alterando la misurazione della temperatura ambiente.
Il radiatore non scalda sufficientemente.	Verificate che non sia stata impostata una temperatura desiderata troppo bassa, che il radiatore stia scaldando il solo locale in cui è installato (tenete chiuse le porte) e che l'alimentazione di rete sia corretta.
Il radiatore scalda in modalità Eco.	È possibile che il radiatore scaldi per raggiungere/mantenere la temperatura di eco. Questo non è un funzionamento anormale.
La superficie del radiatore è molto calda.	È normale che la superficie sia calda durante il funzionamento. I valori massimi rispettano i limiti previsti dalle norme di sicurezza applicabili. Se il prodotto è sempre molto caldo è possibile che sia sottodimensionato per l'ambiente in cui lo si usa oppure sia condizionato da correnti d'aria o spifferi.
La temperatura del locale è diversa dalla temperatura impostata.	Dopo aver atteso la stabilizzazione della temperatura ambiente per almeno 4 ore, è possibile compensare eventuali differenze fra la temperatura indicata sul radiatore e quella rilevata nel locale. A tale scopo fare riferimento a quanto riportato nel paragrafo 6.3 nella sezione intitolata "Allineamento della temperatura esterna".
Il radiatore emette un odore sgradevole.	Quando il radiatore è nuovo è possibile che nei primi minuti di funzionamento emetta un odore sgradevole dovuto a residui di lavorazione nel processo di costruzione. Prodotti già utilizzati possono emettere un odore sgradevole se non vengono utilizzati da molto tempo e/o se vengono utilizzati in ambienti inquinati e con scarsa qualità dell'aria.

8. Manutenzione

- Questo prodotto non richiede particolare manutenzione.
- Vi raccomandiamo di pulire il prodotto ogni 6 utilizzando un panno asciutto.
- Qualora sia necessario riparare il prodotto contattate un centro di assistenza autorizzato.
- Se deve essere sostituito il cavo di alimentazione ricordatevi che deve obbligatoriamente essere utilizzato un cavo tipo 2x1,00 mm² o 3x1,00mm² H05V2V2-F HAR in funzione della versione acquistata. Questa operazione, sia per i cavi dotati di spina che non, deve essere eseguita da personale qualificato e mai dall'utente finale in modo da prevenire ogni rischio di danneggiamento e possibile pericolo.

9. Informazioni legali



Tutela dell'ambiente e riciclaggio

Affinché il vostro apparecchio non subisca danni durante il trasporto, esso è stato imballato con cura. Per contribuire alla tutela del nostro ambiente, vi chiediamo di smaltire in modo appropriato il materiale utilizzato per l'imballaggio dell'apparecchio.

Smaltimento degli apparecchi usati

Gli apparecchi che recano il contrassegno riportato a fianco non devono essere smaltiti insieme ai rifiuti urbani, ma vanno raccolti e smaltiti separatamente. Lo smaltimento degli apparecchi usati va eseguito a regola d'arte, in conformità con le prescrizioni e leggi vigenti localmente in materia.

IT - Informazioni obbligatorie per gli apparecchi per il riscaldamento d'ambiente locale elettrici

Identificativo del modello: KLIMA					
Dato	Simbolo	Valore	Unità	Dato	Unità
Potenza termica				Tipo di potenza termica, solo per gli apparecchi per il riscaldamento d'ambiente locale elettrici ad accumulo (indicare una sola opzione)	
Potenza termica nominale	P_{nom}	(*) vedere Tab. 1	kW	controllo manuale del carico termico, con termostato integrato	no
Potenza termica minima (indicativa)	P_{min}	(*) vedere Tab. 1	kW	controllo manuale del carico termico con riscontro della temperatura ambiente e/o esterna	no
Massima potenza termica continua	$P_{max,c}$	(*) vedere Tab. 1	kW	controllo elettronico del carico termico con riscontro della temperatura ambiente e/o esterna	no
Consumo ausiliario di energia elettrica				potenza termica assistita da ventilatore	no
Alla potenza termica nominale	e_{lmax}	0,000	kW	Tipo di potenza termica/controllo della temperatura ambiente (indicare una sola opzione)	
Alla potenza termica minima	e_{lmin}	0,000	kW	potenza termica a fase unica senza controllo della temperatura ambiente	no
In modo stand-by	e_{lsb}	0,00025	kW	due o più fasi manuali senza controllo della temperatura ambiente	no
				con controllo della temperatura ambiente tramite termostato meccanico	no
				con controllo elettronico della temperatura ambiente	no
				con controllo elettronico della temperatura ambiente e temporizzatore giornaliero	no
				con controllo elettronico della temperatura ambiente e temporizzatore settimanale	si
				Altre opzioni di controllo (è possibile selezionare più opzioni)	
				controllo della temperatura ambiente con rilevamento di presenza	si
				controllo della temperatura ambiente con rilevamento di finestre aperte	si
				con opzione di controllo a distanza	no
				con controllo di avviamento adattabile	no
				con limitazione del tempo di funzionamento	no
				con termometro a globo nero	no
Contatti	Ermete Giudici S.p.A. - via L. da Vinci 27 - 20090 Segrate (MI) Italia				

Tabella 1		KLIMA 7 KLIMA 7 AS	KLIMA 10	KLIMA 15	KLIMA 20
Potenza termica					
Potenza termica nominale	P_{nom}	0,750	1,000	1,500	2,000
Potenza termica minima (indicativa)	P_{min}	0,075	0,113	0,150	0,188
Massima potenza termica continua	$P_{max,c}$	0,750	1,000	1,500	2,000

ENGLISH

OPERATING INSTRUCTIONS

Before operating the heater, please read these instructions thoroughly to avoid damage and hazardous situations. Any use of this heater other than that stipulated in this instruction manual may cause fire, electric shock or injury, and voids all warranties.

Warranty does not apply to any defect, deterioration, loss, injury or damage caused by, or as a result of, the misuse or abuse of this heater. The rights dictated by State law are not prejudiced. None of the terms of this warranty are to be taken as excluding any conditions or warranties implied by State law, which cannot be excluded or modified.

Before any operation remove the packaging and check product integrity. In case of defects or damages do not try to repair it yourself but contact your dealer.

Do not let children play with the packaging and protect the environment by disposing of the packaging in accordance with the national regulations for waste processing.

1. For your safety

- ❑ This appliance is intended for normal household use and not for use in vehicles or on-board ships or aircrafts.
- ❑ This appliance can be used by children aged from 8 years and above and persons with reduced physical, sensory or mental capabilities or lack of experience and knowledge if they have been given supervision or instruction concerning use of the appliance in a safe way and understand the hazards involved. Children shall not play with the appliance. Cleaning and user maintenance shall not be made by children without supervision.
- ❑ Children of less than 3 years should be kept away unless continuously supervised.
- ❑ Children aged from 3 years and less than 8 years shall only switch on/off the appliance provided that it has been placed or installed in its intended normal operating position and they have been given supervision or instruction concerning use of the appliance in a safe way and understand the hazards involved. Children aged from 3 years and less than 8 years shall not plug in, regulate and clean the appliance or perform user maintenance.
- ❑ **CAUTION: Some parts of this product can become very hot and cause burns. Particular attention has to be given where children and vulnerable people are present.**
- ❑ Make sure that the mains power supply matches the rated input: 230V AC, 50Hz.
- ❑ Never allow animals or children to play with or touch the product. Attention! The panel may become very hot while it is working (approximately 80°C=176°F);
- ❑ **WARNING: In order to avoid overheating, do not cover the heater.** Do not hang anything on the heater and do not cover it while

it's working. This is clearly written on the cover of the product or shown by the symbol



- ❑ Do not use the product in rooms saturated with explosive gas, vapours generated by solvents or paints or flammable vapours/gas.
- ❑ If the cable and/or plug are damaged, do not repair them yourself but take the product to the technical service or a qualified repair centre and have them repaired by specialised personnel in order to avoid any risk of damage.
- ❑ Always position the product so that the plug is immediately accessible.
- ❑ Never position this appliance immediately underneath a power socket.
- ❑ Do not insert objects or paper into the radiator.

2. Your product

- ❑ Other than the heater you have chosen the package includes (picture 1):
 - N° 1 metal brackets for wall mounting (fixed to the radiator);
 - N° 4 nylon plug expansion 8x50mm;
 - N° 4 5x60mm cross head screws to fix wall brackets;
- ❑ Refer to your dealer if something is broken or missing.

3. Safe positioning

- ❑ Only use the product in its horizontal position;
- ❑ This product is fitted with a double electrical insulation circuit (class II) and therefore does not require an earth connection;
- ❑ Always make observe the minimum distances from walls, furniture and/or objects, as indicated in picture 2.
- ❑ Never install the product on a surface made from wood or synthetic material.
- ❑ This product is water resistant to IP24. It may therefore be used in bathrooms or other areas subject to humidity provided it is never installed within the perimeter of bathtubs or showers (Volume 1 of figure 2).
- ❑ Do not install the radiator in a draft that could disturb its regulation.

4. Installation

- ❑ Remove the wall-mounting bracket fixed to the back of the radiator, by releasing first the 2 upper springs and then the 2 lower springs as shown in figure 4.
- ❑ Rest the bracket on the floor to use it as a template to mark the points a which the two lower fixing holes are to be made (figure 5A).
- ❑ Lift the bracket until its lower fixing points coincide with the marks made on the wall before and use a pencil to mark the position of the two upper fixing points (figure 5B).
- ❑ Drill the 4 holes at the points marked previously and insert the plastic anchors (figure 6).
- ❑ Fix the bracket to the wall using the 4 screws supplied (figure 7).
- ❑ Hook the radiator to the bracket starting with the 2 lower fixing points, and then click the 2 upper fixing points into position (figure 8).
- ❑ Should you have to remove the radiator from the bracket at a later stage, we recommend releasing the lower two fixing points first and then the upper fixings.

5. Electrical connections

- ❑ The product must be powered at a voltage of 230V AC 50Hz.
- ❑ The product must be supplied with a cable and plug or with a cable for installation. If a product with plug is installed in France, connect it to the mains power supply by cutting off the plug and using a suitable connection box.
- ❑ If the product is supplied with a cable for installation without plug, connect it to the mains power supply using a 3-wire cable (Brown=Live, Blue=Neutral, Black= Pilot wire) and a connection box. **If you do not wish to use the pilot wire**

functions, just connect the phase and the neutral wires: the product will work correctly even without the external programmer.

- ❑ In bathrooms, kitchens or other humid areas, install the connection terminal at least 25cm off the floor.
- ❑ The electrical connection to the mains power supply must also include a 2-pole switch with a minimum contact aperture of 3mm. As a priority, always abide you national wiring rules.
- ❑ It is forbidden to connect the appliance to the earth circuit. **DO NOT CONNECT THE PILOT WIRE (BLACK) TO THE EARTH CIRCUIT.**
- ❑ If the product is powered through a 30mA differential switch, make sure the pilot wire is also controlled by the differential switch.

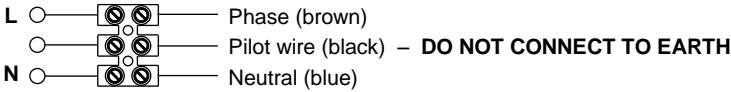

6. Using the product

6.1 Description of controls

- A – Switch on/Stand-by
- B – Operating mode
- C – Special functions
- D – Increase / Activate
- E – Decrease / Deactivate
- F – Display
- G – Main switch

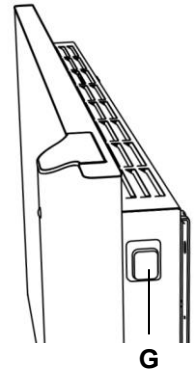
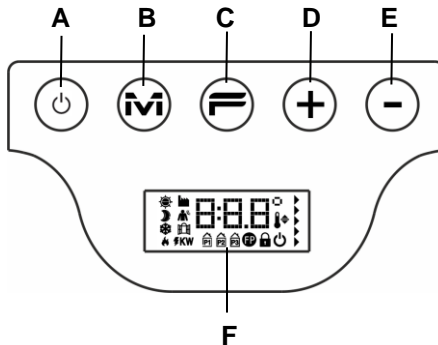

6.2 Operating

6.2.1 Switching on the screen

If the screen is not switched on, push any key to make it light up.
 The screen lights up and stays on for 30 seconds after the last time any key is pushed.







When the screen is switched off, the first time any key is pushed the screen lights up without activating the function controlled by the key pushed.



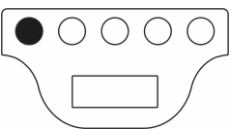

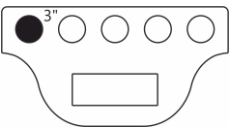

6.2.2 Switching the radiator on and off

The power supply to the radiator is controlled by a two-pole electromechanical switch (G) located on the right side of the radiator. When this switch is used the power supply to the electronic board is also switched off and, as a result, all the parameters saved are lost after about 30 minutes, and the default settings are reinstated.

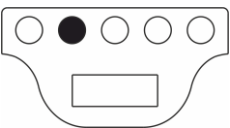
We recommend only using this switch if the radiator is not to be used for a long period of time, and to rather use the Switch on / Stand by button (A) for switching off for short periods, in order to avoid losing the settings saved.

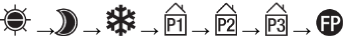
<p>When the radiator is switched on using the main switch on its side, the display lights up and the stand-by symbol is displayed.</p>		
<p>To switch on the radiator, push the Switch on / Stand-by key.</p> 		<p>The radiator always comes on in comfort mode. If the radiator is new or the power supply has been off for more than 30 minutes, the comfort temperature is at the default value of 19°C.</p>
<p>To switch off the radiator, hold down the Switch on / Stand-by key for at least 3 seconds.</p> 		<p>Switching the radiator off using the rocking switch on its side for more than 30 minutes results in the loss of all data saved (date, time, temperature setting, etc.).</p>

6.2.3 Selecting the operating mode

<p>Pressing the "M" key repeatedly allows you to select the operating mode you require.</p> 		<p>The operating modes are activated in the following order:</p>  <p>Once 30" has elapsed since the "M" key was last pushed, the operating mode activation sequence begins from the beginning again, to make it quicker to switch from any mode to Comfort mode.</p>
Icon	Description	When used
	Comfort	When at home the radiator works to maintain the comfort temperature set.
	Eco	When you are away from home for short periods (from 2 to 48 hours) or you are sleeping. The radiator works to maintain the eco temperature set and save energy.
	Anti-freeze	When you are away from home for long periods (more than 48 hours). The temperature is automatically set at 7±3°C and cannot be changed.
	Programme P1	When you want preset programmed operation, suitable for those that do not work from home. THIS PROGRAM CAN ALSO BE CUSTOMIZED FOLLOWING THE INSTRUCTIONS LISTED IN PARAGRAPH 6.2.6.

The preset eco temperature is 15,5°C and can be changed using the “+” or “-” keys.

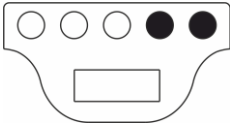

The recommended difference between the comfort and eco temperature values is 3,5°C. If the difference set differs from the suggested value, the eco symbol changes as follows:



The maximum value that can be set for the eco temperature is equal to the comfort temperature value - 0,5°C.

If the ambient temperature is lower than the temperature required and displayed, the heating indicator switches on, on the display .

6.2.5 Setting the day and time

The day and time are set to be able to use the 3 preset programmes, and this can be done by holding down the mode key.

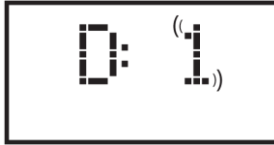
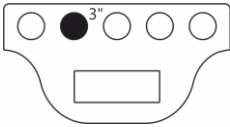

The day flashes the day to be set (1 = Monday). To edit it, push the “+” or “-” keys.

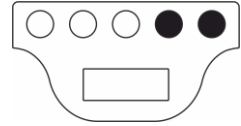

Push the mode key to confirm the day set and move on to setting the time.

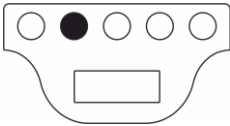

The display flashes the hour to be set. To edit it, push the “+” or “-” keys.

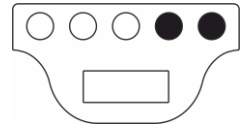

Push the mode key to confirm the hour set and move on to setting the minutes.

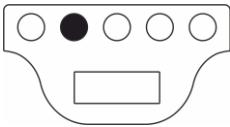

The display flashes the minutes to be set. To edit it, push the “+” or “-” keys.

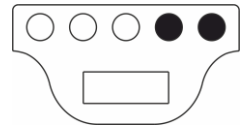

Push the mode key to confirm the minutes set and conclude the setting operation.

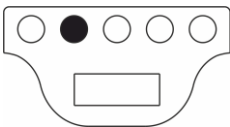

The system will go back to the operating mode activated when setting was started.

If you try to activate a preset programme without having saved the date and time, this setting procedure will be activated automatically.











6.2.6 Customizing P1 Program

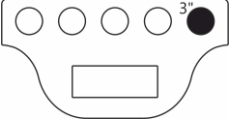

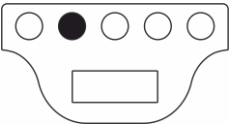

Program P1 may be modified to suit the users needs. Modification of P1 gives the user the opportunity to set the wished ambient temperature, choosing among Comfort, ECO o Frost Free, for every hour of the day and for the whole week.

Please refer to paragraph 6.2.4 in order to set different levels of temperature to each working Mode.

Each displayed hour of the day shows the temperature level of P1 Program currently set. In case of first use of the radiator, the set P1 Program profile is the one indicated in Paragraph 6.2.3.1.

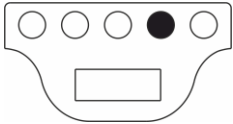

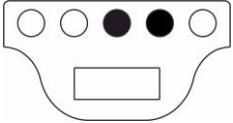
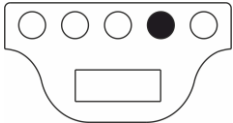
In order to display or modify P1 Program, please proceed as follows:

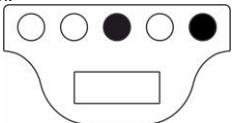





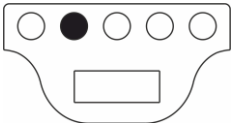



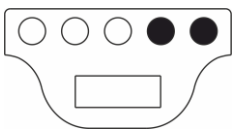
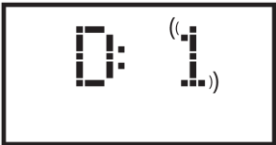
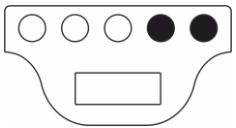

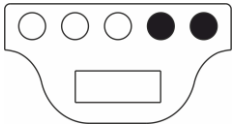

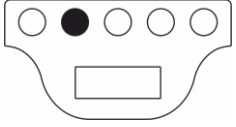

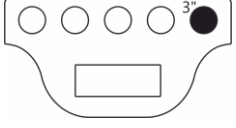
<p>Press "M" to select P1 Program.</p> 		<p>In case Time has not been set previously (brand-new product, or lack of power connection longer than 30 min.) the time regulation procedure will be activated automatically (refer to paragraph 6.2.5)</p>
<p>To display P1 Program hold button "-" for 3 seconds.</p> 		<p>The first day to see/modify is now displayed (1= Monday)</p>
<p>Press "+" button to enter the first hour to see/modify.</p> 		<p>Press "M" button to choose the wished temperature level among Comfort, Eco or Frost Free:</p>   <p>The displayed temperature once you've selected a specific hour of the day, is the one currently set on the P1 Program.</p>
<p>Use "+" and "-" buttons to enter each hour of day 1 and see/modify the working temperature of each of them.</p> 		<p>The hour displayed always indicates the starting point. For example: when H 23 is displayed the modification involves the period of time between 23:00 and 00:00.</p>

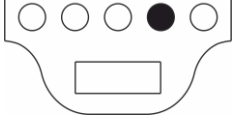
<p>Having modified the temperature for each of the 23 hours of Day 1, press further "+" button to enter the modification mode of Day 2.</p> 		<p>Press "+" button to display/modify the working temperature of each hour of Day 2, as described for Day 1. You can set automatically the same program of Day 1 on Day 2 by holding the "F" button and pressing "+" button.</p>  <p>Note: you are allowed to copy and paste the same daily program ONLY WHEN the number of the day you wish to adjust is displayed (as shown in the picture), BUT NOT when the hour is displayed.</p>
<p>Once the last day (Day 7) has been set, press "+" button to end the program sequence.</p> 		<p>END will appear on the display. A further press of "+" button will allow you to confirm the adjusted program.</p>
<p>"OK" will appear on the display for 5 seconds, confirming that the Program sequence has been carried out successfully. System is now set to adjust the temperature according to the new adjustment of program P1.</p>		<p>Note: it is possible to exit any time from the program sequence, without displaying every hour until Day 7. To do so, just hold "F" button and press "-" button.</p> 
<p>N.B.:</p> <ul style="list-style-type: none"> - You can abort the display/modification sequence anytime, deleting any settings that have not been saved, just by pressing "Stand-By" button; - Restoring the default settings will delete every P1 Program previously created (see paragraph 6.3); - If no button is pressed within 90 sec. during the Program setting process, the result will be the cancellation of the display/modification procedure and will restore back the factory default settings; - During the programming process, the heating elements will automatically switch to Stand-by mode, and the radiator does not heat. 		

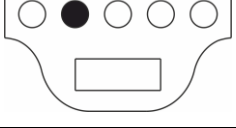
EXAMPLE: HOW TO SET A CUSTOM PROGRAM

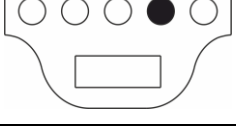
Let's see how to program a brand-new radiator and anticipate the change from ECO to COMFORT temperature one hour earlier (06:00 a.m. is the default factory settings), for each day from Monday to Friday.

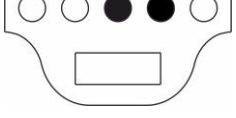





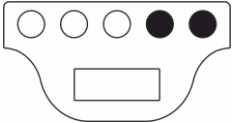

<p>Press "M" to select Program P1</p>		
---------------------------------------	---	--

<p>Set the current day of the week (first use of the radiator) using "+" or "-" button.</p>		
<p>Press "M" and set the current Hour (first use of the radiator) using "+" or "-" button.</p>		
<p>Press "M" and set the current Minutes (first use of the radiator) using "+" or "-" button.</p>		
<p>Press "M" to end the time setting procedure. System now gets back to Program P1.</p>		
<p>Hold "-" for 3 sec. To enter the display/modification of Day 1.</p>		
<p>Press "+" until you'll see H:05 on the display (that's the hour we want to modify the ECO temperature level to COMFORT).</p>		
<p>Press "M" two times to change the ECO temperature level to COMFORT.</p>		
<p>Press "+" button until you'll see D:2 appear on the display (Tuesday)</p>		
<p>To copy and paste the same program of Day 1 on Day 2, hold "F" and press "+" button. The system will automatically copy the program and display directly Day 3 (Wednesday).</p>		

<p>Repeat the procedure previously described until D:6 appears on the display.</p>		
<p>Since we don't want to modify Day 6 and 7, we can exit the Program settings mode, holding "F" and pressing "-" button. "END" will appear on the display.</p>		
<p>Press "+" to confirm the modification process. "OK" will be flashing on the display for 5 sec.</p>		

6.3 Special functions

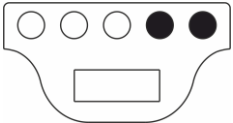
<p>Repeatedly pushing the "F" key makes it possible to select the various special functions available in sequence.</p>		<p>To leave the special functions menu, simply wait 12 seconds, or push the "M" key to go back to viewing the operating mode.</p>
<p>Reinstating default settings</p>		<p>To reinstate all the radiator's parameters to the default settings set by the manufacturer hold at least for 3sec the "+" key down.</p>
<p>Presence sensor</p> <p>This function allows the radiator to pick up whether or not people are in the space, and automatically regulate the heating level, in order to optimise comfort and energy saving.</p> <p>For further details see paragraph 6.3.1.</p>		<p>Switching the function (ON) or (OFF) is done by pushing the "+" or "-" keys respectively.</p> <p>Activation is indicated by the relevant icon that switches on, on the display </p>

<p>Window open sensor</p> <p>This function makes it possible to detect an open window and automatically activate the anti-freeze operating mode.</p> <p>For further details see paragraph 6.3.2.</p>		<p>Switching the function (ON) or (OFF) is done by pushing the "+" or "-" keys respectively.</p>  <p>Activation is indicated by the relevant icon that switches on, on the display </p>
<p>Daily consumption</p> <p>This function makes it possible to view the power the radiator has consumed over the previous 24 hours.</p>		<p>If the consumption indication is flashing, this means that the data saved relates to a period of less than 24 hours.</p> <p>Please note: The display shows the estimated consumption, which may differ from that measured by specific meters, suitable for the purpose.</p>
<p>Weekly consumption</p> <p>This function makes it possible to view the power the radiator has consumed over the previous 7 days.</p>		<p>If the consumption indication is flashing, this means that the data saved relates to a period of less than 7 days.</p> <p>Please note: The display shows the estimated consumption, which may differ from that measured by specific meters, suitable for the purpose.</p>
<p>Displaying the ambient temperature</p>		<p>The display shows the ambient temperature measured by the radiator.</p>
<p>Alignment of the ambient temperature</p> <p>This function is used to edit the ambient temperature measured by the radiator and used to manage heating power, if it needs to be corrected to compensate for reading errors due to things like being near to heat sources, or cold air draughts.</p>		<p>The display flashes the correction value to be applied. To edit it, push the "+" or "-" keys.</p>  <p>If, for example, the temperature set on the radiator is 19,2°C and the ambient temperature is measured at 19,5°C, align it by +0,3°C.</p> <p> Always wait at least 4 hours for the temperature to settle, before doing any alignment.</p>
<p>Remote control</p> <p>This function allows the radiator to be controlled using external timers, piloted sockets with telephonic control, and similar devices.</p>		<p>Switching the function (ON) or (OFF) is done by pushing the "+" or "-" keys respectively.</p>

For further details see paragraph 6.3.3.

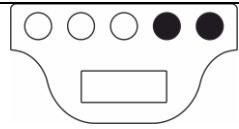



Warning: Activation is NOT indicated by any icon on the display.

6.3.1 Presence sensor

This function allows the radiator to pick up whether or not people are in the space, and automatically regulate the heating level, in order to optimise comfort and energy saving.

Thanks to this function, which can only be activated in Comfort mode, the radiator continuously monitors the room and, if no people are detected, it reduces the comfort temperature set as follows:

Period of absence	Reduction of the Comfort temperature	Indication on the display
60 min	1,0°C	The presence sensor and comfort mode symbols flash together   (())
90 min	2,0°C	
120 min	3,5°C	
38 hours	Anti-freeze activated 7±3°C	

The reduction in temperature always relates to the comfort temperature. If the radiator is in Eco or Anti-freeze mode, no change in temperature to be maintained in the room will be observed.

Should someone be detected in the room for at least 10 consecutive minutes, the temperature is automatically returned to the comfort temperature set, without any reduction. The same happens if, while the temperature required is being reduced, due to an absence of people being detected in the room, the "M" key is pushed.

Important:

Correct operation of this function may depend on where the radiator is positioned in the room. To choose the best installation position, bear in mind that the sensor detects movements within the area indicated in figure 9, and that no objects must be in its way. Presence detection is also more effective when people move in front of the sensor than when they move towards it.

6.3.2 Open window sensor

This function makes it possible to detect an open window and automatically activate the Anti-freeze operating mode. If a sudden reduction in temperature is detected when the radiator is operating normally, anti-freeze mode is activated automatically to reduce energy wastage. On the display the window and anti-freeze symbols flash together, while the symbol for the operating mode set by the user stays on.



Reinstating normal operation does not occur automatically but must be activated by pushing the "M" key.

Important:

Correct operation of this function may depend on where the radiator is positioned in the room, the presence of draughts, the outside temperature, and how long the window stays open.

6.3.3 Remote control

This function allows the radiator to be controlled using external timers, piloted sockets with telephonic control, and similar devices. When the function is active, if the radiator's power supply is reinstated after being interrupted for more than 30 minutes, when it is switched on Stand-by mode is not set as normally happens, by Comfort mode starts immediately. The comfort temperature is as set before the power supply was interrupted. The (optional) presence sensor and open window sensor are deactivated. This means that the radiator can be switched on without being in the room.

6.4 Utilities

Lock controls

The radiator's controls can be locked to prevent settings being changed accidentally, or by unauthorised people. To go to lock/unlock mode, hold the "F" key down.

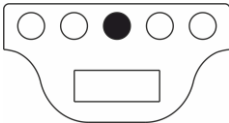

Once the display reads "LOC":

Hold the "F" key down and push the "+" key to lock the controls.

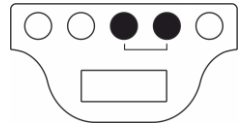

Activation is indicated by the relevant icon that switches on, on the display 

Hold the "F" key down and push the "-" key to unlock the controls.



When this function is activated, in case the supply voltage returns after an interruption exceeding 30min, the operating mode set at the time of the interruption is recovered. If the operating mode was one of the three programs P1, P2 or P3 the frost-free program is activated instead, because it is necessary to set the time and the day of the week before activating again a program.

7. Troubleshooting

Problem	Solution
The radiator does not switch on.	Check that the power supply is on and that it is as indicated in the radiator's nameplate (e.g. 230 Vac 50 Hz), and that the main switch on the right side of the radiator is switched on (position "I").
The radiator does not heat up.	Make sure that the operating mode is as required and, if using a preset programme, that you are not in a time period for which anti-freeze mode is set. If the ambient temperature is higher than that set, the radiator should not heat up. If in doubt, set Comfort mode and a required temperature much higher than the ambient temperature, to check that the radiator is working properly.
The radiator stays hot.	Check that the temperature setting is not too high or that there are no draughts on the radiator, altering the ambient temperature measured.
The radiator does not heat up enough.	Check that the temperature setting is not too low, that the radiator is only heating the room in which it is installed (keep the doors closed) and that the mains power supply is correct.
The radiator heats in Eco mode.	The radiator may heat up to reach / maintain the eco temperature. This is not abnormal operation.
The radiator's surface is very hot.	It is normal for the surface to be hot when working. The maximum values comply with the limits laid down by applicable safety norms. If the radiator is always very hot, it may be undersized for the space in which it is used or may be affected by draughts.
The temperature in the room differs from the temperature set.	Having waited for the ambient temperature to stabilise for at least 4 hours, you may have to compensate for any differences between the temperature indicated by the radiator and that measured in the room. To do this see the contents of paragraph 6.3 on the section "Aligning the outside temperature".
The radiator gives off an unpleasant odour.	When the radiator is new, it is possible that when it begins working for the first time an unpleasant odour may be sensed. This is due to residue from the manufacturing process. Radiators that have already been used may give off unpleasant odours if they are not used for a long time and/or if they are used in polluted spaces with poor quality air.

8. Maintenance

- This product does not require any special maintenance.
- Clean the product, especially the heating panel, with a dry cloth once every 6 months.
- If the product requires repairing, contact an authorised technical service centre.
- When replacing the power cable, use a 2x1,00mm² or 3x1,00mm² H05V2V2-F HAR type, depending on the version. This operation, for cables both with and without plugs, must be performed by qualified personnel and never by the end user in order to avoid damaging the appliance and jeopardising personal safety.

9. Legal notice



Environment and recycling

Please help us to protect the environment by disposing of the packaging in accordance with the national regulations for waste processing.

Recycling of obsolete appliances

Appliances with this label must not be disposed off with the general waste. They must be collected separately and disposed off according to local regulations.

EN - Information requirements for electric local space heaters

Model identifier(s): KLIMA					
Item	Symbol	Value	Unit	Item	Unit
Heat output				Type of heat input, for electric storage local space heaters only (select one)	
Nominal heat output	P_{nom}	(*) see Table 1	kW	manual heat charge control, with integrated thermostat	no
Minimum heat output (indicative)	P_{min}	(*) see Table 1	kW	manual heat charge control with room and/or outdoor temperature feedback	no
Maximum continuous heat output	$P_{max,c}$	(*) see Table 1	kW	electronic heat charge control with room and/or outdoor temperature feedback	no
Auxiliary electricity consumption				fan assisted heat output	no
At nominal heat output	e_{lmax}	0,000	kW	Type of heat output/room temperature control (select one)	
At minimum heat output	e_{lmin}	0,000	kW	single stage heat output and no room temperature control	no
In standby mode	e_{lsb}	0,00025	kW	Two or more manual stages, no room temperature control	no
				with mechanic thermostat room temperature control	no
				with electronic room temperature control	no
				electronic room temperature control plus day timer	no
				electronic room temperature control plus week timer	yes
				Other control options (multiple selections possible)	
				room temperature control, with presence detection	yes
				room temperature control, with open window detection	yes
				with distance control option	no
				with adaptive start control	no
				with working time limitation	no
				with black bulb sensor	no
Contact details	Ermete Giudici S.p.A. - via L. da Vinci 27 - 20090 Segrate (MI) Italia				

Table 1		KLIMA 7 KLIMA 7 AS	KLIMA 10	KLIMA 15	KLIMA 20
Heat output					
Nominal heat output	P_{nom}	0,750	1,000	1,500	2,000
Minimum heat output (indicative)	P_{min}	0,075	0,113	0,150	0,188
Maximum continuous heat output	$P_{max,c}$	0,750	1,000	1,500	2,000

ROMANA

MANUAL DE INSTALARE SI FOLOSIRE

Inainte de a utiliza incalzitorul, va rugam sa cititi cu atentie manualul de instructiuni, pentru a evita situatiile periculoase la care ati putea fi supusi. Orice utilizare a acestui aparat, alta decat cea prezentata in acest manual poate cauza ardere, socuri electrice sau raniri, si nu face obiectul garantiei aparatului.

Garantia nu se aplica in cazul oricaror defecte, deteriorari, pierderi, loviri sau daune datorate utilizarii incorecte a produsului. Raman in vigoare toate drepturile garantate de lege. Nici o conditie de garantie nu poate exclude sau modifica conditiile de garantie reglementate prin legile statului care nu pot fi in nici un mod modificate sau excluse.

Inainte de orice operatiune, indepartati cu grija ambalajul si controlati integritatea produsului. In cazul in care se observa defecte sau lovituri, nu instalati si nu incercati sa reparati aparatul, contactati furnizorul.

Nu lasati ambalajul la indemana copiilor si separati-l in parti componente in conformitate cu legile in vigoare.

1. Pentru siguranta d-vs.

- ❑ Acest aparat se adreseaza utilizarii casnice si nu pentru utilizare in autovehicule, la bordul navelor sau avioanelor.
- ❑ Acest produs nu trebuie utilizat de persoane (inclusiv copii) cu capacitati fizice, senzoriale sau mentale reduse sau cu experienta si cunostinte inadecvate, care nu sunt sub supravegherea unei persoane responsabile pentru siguranta lor sau care nu sunt instruite adecvat de catre o astfel de persoana. Copiii trebuie supravegheati pentru a va asigura ca nu se joaca cu aparatul. Curatarea si intretinerea nu se va face de catre copii fara supravegherea unui adult.
- ❑ Copiii sub 3 ani trebuie tinuti departe de aparat si supravegheati temeinic.
- ❑ Copiii intre 3 si 8 ani pot sa porneasca/opreasca aparatul cu conditia ca acesta sa fie pozitionat si instalat in pozitia dorita si functionand normal. Copiii trebuie instruiti in prealabil despre normele de siguranta si utilizare, operarea facandu-se in prezenta unui adult. Copiii intre 3 si 8 ani nu vor manevra stecherul conector la sursa de energie, nu vor regla, curata sau repara aparatul.
- ❑ **ATENTIE — parti ale aparatului pot deveni fierbinti in timpul functionarii si pot cauza arsuri. Atentie deosebita se va acorda copiilor si persoanelor vulnerabile atunci cand sunt in preajma aparatului.**
- ❑ Asigurati-va ca alimentarea de la retea corespunde cu datele de pe eticheta: 230VAC, 50Hz.
- ❑ Nu lasati copiii sau animalele sa atinga sau sa se joace cu aparatul. ATENTIE! Panoul se incalzeste in timpul functionarii si poate deveni foarte fierbinte. (aproximativ 80°C=176°F);
- ❑ **ATENTIONARE! Pentru a evita supraincalzirea, nu acoperiti aparatul! Nu agatati nimic pe incalzitor si nu il acoperiti in**

timpul functionarii. Acest lucru este inscriptiionat pe produs sau aratat de simbolul:



- Nu utilizati aparatul in incaperi cu gaze inflamabile sau in timp ce folositi solventi inflamabili, lacuri sau cleiuri.
- Daca firul de alimentare este deteriorat si trebuie schimbat, nu faceti asta singuri! Duceti produsul la un centru de reparatii autorizat sau la o persoana calificata pentru astfel de situatii, pentru a evita orice risc sau pericol.
- Aparatul trebuie amplasat in asa fel incat priza sa fie accesibila.
- Nu amplasati aparatul in imediata apropiere a prizelor.
- Nu introduceti obiecte sau hartie in radiator.

2. Produsul d-vs.

- Ce mai cuprinde pachetul pe langa aparatul de incalzire (imagine1):
 - N° 1 suporti metalici pentru montajul pe perete (fixati pe radiator);
 - N° 4 dibluri de plastic 8x50mm;
 - N° 4 5x60mm suruburi cap stea pentru a fixa suportii de perete;
- Adresati-va dealer-ului daca ceva este stricat sau lipseste.

3. Pozitionare corecta

- Montajul si utilizarea aparatului se va face doar in pozitia orizontala;
- Aparatul este construit cu dubla izolare electrica (clasa II) deci nu este necesara impamantarea;
- Atentie la distanta minima fata de pereti, mobilier si alte obiecte, asa cum se indica in imaginea 2;
- Nu instalati niciodata produsul pe suprafete de lemn sau din material sintetic.
- Aparatul are grad de protectie la apa IP24. Poate fi utilizat in bai si in spatii umede dar niciodata in perimetrul cazii sau dusului (volumul 1 din figura 3).
- Butoanele de reglare nu trebuie in nici un caz sa fie accesibile de catre persoanele care se afla in cada sau dus.
- Nu incastrati aparatul in mobilier, acest lucru duce la functionare defectuoasa

4. Instalare

- Desfaceti suportii de fixare pe perete, de pe spatele radiatorului; desfaceti cele 2 cleme pozitionate pe partea superioara a aparatului , apoi celelalte 2 cleme din partea inferioara (vezi imaginea 4)
- Asezati suportul pe podea ca sa il folositi ca sablon pentru a marca punctele de fixare inferioare si a putea face gaurile (imaginea 5A)
- Ridicati suportul pana cand punctele inferioare coincid cu marcajele facute anterior pe perete. Folositi un creion pentru a marca pozitia a celor 2 puncte de fixare superioare. (imaginea 5B)
- Faceti gaurile in punctele marcate anterior si introduceti diblurile de plastic (imaginea 6)
- Fixati suportul pe perete folosind cele 4 suruburi din pachetul de instalare. (imaginea 7)
- Agatati aparatul pe suport incepand cu cele 2 puncte inferioare de fixare, dupa care apasati punctele de fixare pe pozitie (imaginea 8)
- În cazul în care va trebui să scoateți radiatorul din suport într-o etapă ulterioară, vă recomandăm să eliberarati cele 2 puncte de fixare de jos mai întâi și apoi cele superioare.

5. Conectarea electrica

- Aparatul trebuie alimentat la 230V AC 50Hz.
- Produsul poate fi furnizat cu cablu si stecher sau doar cu cablu pentru instalare. Daca aparatul se instaleaza in Franta conectati-l la reteaua principala de electricitate prin taierea stecherului si legarea la retea printr-o doza.
- Cand produsul este dotat cu cablu de alimentare, legarea trebuie efectuata utilizand trei fire (Maro=Faza, Albastru=Nul, Negru=Fir pilot) si o doza electrica. **Daca nu se doreste utilizarea functionalitatii firului pilot limitati-va la legarea fazei si nulului: produsul va functiona corect si fara prezenta programatorului extern.**
- In spatii umede, in bai sau bucatarii, conexiunea de legatura trebuie instalata la minim 25 cm de pardoseala

- ❑ Legatura electrica la retea trebuie sa fie prevazuta cu un intrerupator bipolar la o distanta minima de deschidere intre contacte de minim 3 mm. Respectati intotdeauna in mod prioritar regulile de instalare in vigoare din tara dumneavoastra.
- ❑ Legarea la impamantare este interzisa. **NU LEGATI LA IMPAMANTARE FIRUL PILOT (NEGRU).**
- ❑ Daca produsul trebuie alimentat prin intermediul unui intrerupator diferential de siguranta de 30mA, se poate ca firul pilot sa fie sub controlul intrerupatorului diferential.

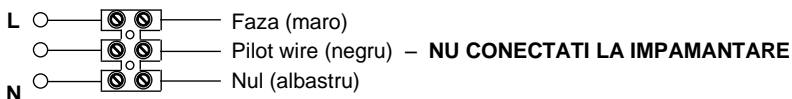

6. Utilizarea produsului

6.1 Descrierea functiilor

- A – Pornire / Stand-by
- B – Mod de functionare
- C – Functii speciale
- D – Crestere / Activare
- E – Descrestere / Dezactivare
- F – Afisaj
- G – Intrerupatorul principal

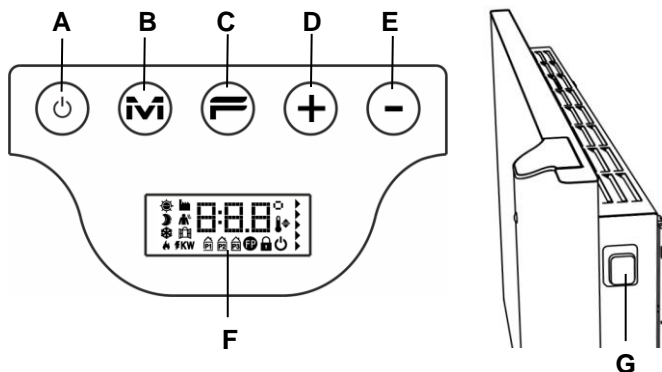

6.2 Functionare

6.2.1 Pornirea afisajului

Daca afisajul nu este pornit, apasati orice buton ca sa il porniti.

Afisajul se ilumineaza si ramane in stand-by pentru 30 de secunde dupa ultima apasare de buton

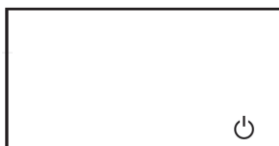





Cand afisajul este stins, la orice atingere a unui buton se ilumineaza fara a activa functia butonului apasat.

6.2.2 Pornirea si oprirea radiatorului

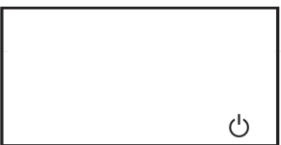
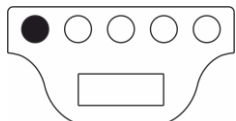

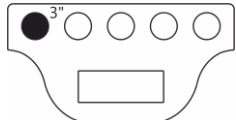

Alimentarea cu energie a radiatorului este controlata de un intrerupator electromecanic bipolar (G), localizat pe partea dreapta a radiatorului. Atunci cand intrerupatorul este oprit nu se alimenteaza nici placa electronica, ceea ce face ca toti parametrii salvati sa fie pierduti dupa 30 de minute si setarile din fabrica sa fie activate.





Recomandam utilizarea intrerupatorului doar atunci cand radiatorul nu se foloseste perioade mai indelungate, in rest utilizati butonul Pornire / Stand-by (A) pentru a opri aparatul pentru perioade scurte de timp, in acest fel nu se vor pierde setarile salvate de d-vs.

<p>Cand radiatorul este pornit utilizand intrerupatorul principal de pe partea laterala, afisajul este iluminat si simbolul de stand-by este aratat.</p>		
<p>Pentru a porni radiatorul apasati butonul Pornire / Stand by</p> 		<p>Radiatorul vine din fabrica cu setarile pe modul confort. Daca aparatul este nou sau alimentarea cu energie a fost intrerupta mai mult de 30 de minute, aparatul se reseteaza pe valoarea din fabrica de 19°C.</p>
<p>Pentru a opri aparatul tineti apasat butonul Pornire / Stand-by pentru 3 secunde</p> 		<p>Oprirea aparatului de la intrerupator lateral pentru mai mult de 30 de minute duce la pierderea datelor salvate (data, ora, setarile de temperatura, etc.)</p>







6.2.3 Selectarea modului de operare

<p>Apasand butonul 'M' repetat va va permite sa selectati modul de functionare pe care il doriti.</p> 		<p>Modurile de functionare sunt activate in ordinea urmatoare:</p>  <p>Dupa trecerea celor 30 de sec. de la ultima apasare a tastei M, secventa modului de operare se reia de la inceput, pentru a face mai usor transferul de la orice mod de control catre modul Confort.</p>
---	--	--

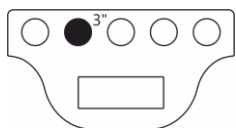
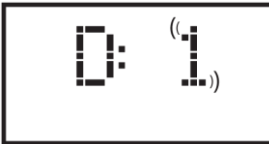
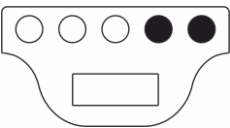
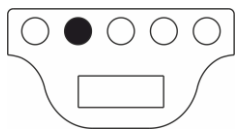
Simbol	Descriere	Cand se utilizeaza
	Confort	Cand sunteti acasa radiatorul functioneaza pentru a mentine temperatura de confort setata de d-vs.
	Eco	Cand nu sunteti acasa pentru perioade scurte (de la 2 la 48 de ore) sau dormiti. Radiatorul functioneaza pentru temperaturii eco si economisire de energie.
	Anti-inghet	Cand sunteti plecat de acasa pentru perioade mai lungi de timp (mai mult de 48 de ore). Temperatura este automat setata la 7±3°C si nu poate fi schimbata.
	Program P1	Când doriți funcționarea programului prestabilit, potrivit pentru cei care nu lucreaza la domiciliu. Acest program poate fi personalizat urmând instrucțiunile enumerate la punctul 6.2.6.

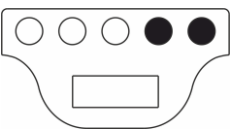
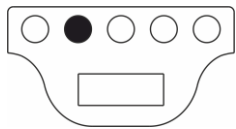
<p>Temperatura ECO presetata este de 15,5°C si poate fi schimbata utilizand butoanele "+" sau "-".</p> 		<p>Diferenta recomandata intre temperatura de confort si ECO este de 3,5 °C. Daca diferenta setata difera de valoarea sugerata, simbolul ECO se va schimba dupa cum urmeaza:</p>  <p>Valoarea maxima pe care o puteti seta pentru temperatura ECO este cu 0,5°C mai mica decat temperatura de confort.</p>
<p>Daca temperatura ambientala este mai mica decat temperatura setata si aratata pe ecran, indicatorul de caldura va porni pe ecran .</p>		

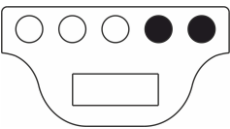
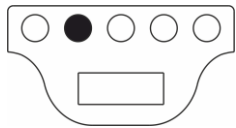
6.2.5 Setarea zilei si orei

<p>Ziua si ora sunt necesare pentru a putea folosi cele 3 programe presetate, aceasta se poate face tinand apasata tasta M (mod de functionare).</p> 		<p>Litera D palpaie si poate fi setata ziua (1= Luni), pentru a modifica apasati butoanele "+" sau "-".</p> 
<p>Apasati butonul M (mod de functionare) pentru a confirma ziua setata si a trece la setarea orei.</p> 		<p>Litera H palpaie si poate fi setata ora, pentru a modifica apasati butoanele "+" sau "-".</p> 
<p>Apasati butonul M (mod de functionare) pentru a confirma ora setata si a trece la setarea minutelor.</p> 		<p>Litera M palpaie si poate fi setat minutul, pentru a modifica apasati butoanele "+" sau "-".</p> 
<p>Apasati butonul M (mod de functionare) pentru a confirma fixarea minutelor si a confirma aceste setari.</p> 		<p>Sistemul se va intoarce la modul de operare activat la inceputul programarii.</p> <p>Daca incercati sa activati un program presetat fara a salva ora si data, aceasta procedura de programare se va activa automat.</p>









6.2.6 Personalizarea Programului P1

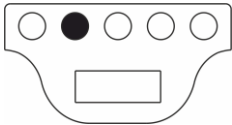

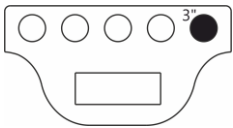

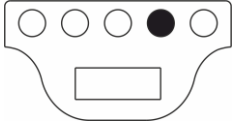
Programul P1 poate fi modificat pentru a raspunde nevoilor utilizatorului. Modificarile P1 dau utilizatorului posibilitatea de a seta temperatura ambientala dorita, alegand intre CONFORT, ECO, sau ANTI-INGHET, pentru fiecare ora a zilei si a intregii saptamani.

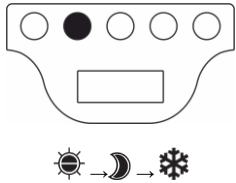
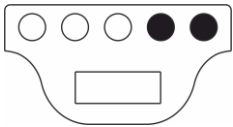
Reveniti la paragraful 6.2.4 pentru a seta temperaturile la fiecare Mod de functionare.

Fiecare ora afisata, arata nivelul temperaturii programului P1 ales de d-vs. La prima utilizare a aparatului profilul programului P1 este cel indicat in paragraful 6.2.3.1.

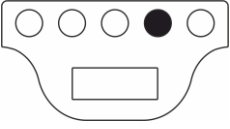

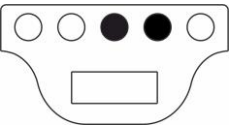
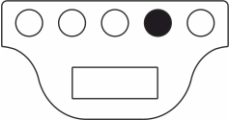

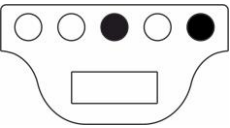





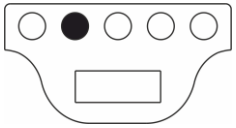

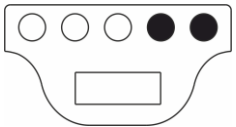
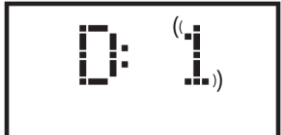
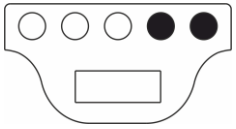

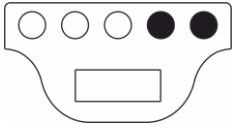
pentru a modifica sau afisa programul P1, urmati pasii:

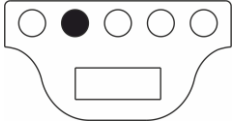

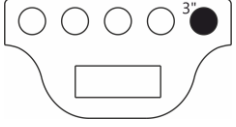

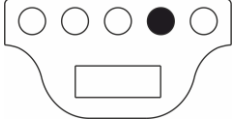

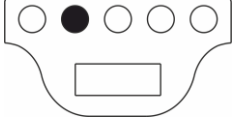

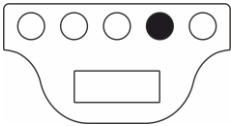

<p>Apasati tasta "M" pentru a selecta programul P1.</p> 		<p>In cazul in care ORA nu a fost setata anterior (produs nou sau date pierdute datorita lipsei de energie electrica mai mult de 30 min.) procedura de reglare a orei se va activa automat. (vezi paragraful 6.2.5)</p>
<p>Pentru a afisa P1 apasati butonul "-" pentru 3 secunde.</p> 		<p>Prima zi pe care o vedeti (1= Luni)</p>
<p>Apasati butonul "+" pentru a accesa ORA vizualizare/modificare.</p> 		<p>Apasati butonul "M" pentru a alege temperatura dorita intre CONFORT, ECO, ANTI-INGHET</p>  <p>Dupa setarea zilei si orei, temperatura afisata este cea aleasa pe programul P1.</p>
<p>Folositi butoanele "+" si "-" pentru a introduce fiecare ora pentru ziua 1 si a vedea/modifica temperatura de lucru pentru fiecare din ele.</p> 		<p>Ora afisata indica intotdeauna punctul de pornire. De ex.: cand este afisat H:23, modificarile privesc intervalul de timp dintre 23:00 si 00:00.</p>

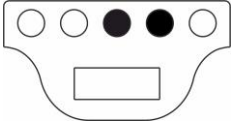
<p>Dupa ce ati terminat de modificat temperatura pentru fiecare din cele 23 de ore pentru ZIUA 1, mai departe apasati butonul "+" pentru a introduce modificarile ZILEI 2.</p> 		<p>Apasati butonul "+" pentru a afisa/modifica temperatura de lucru pentru fiecare ora a ZILEI 2 asa cum s-a descris pentru ZIUA 1. Puteti seta automat acelasi program al ZILEI 1 pentru ZIUA 2, prin tinand apasat butonul "F" si si apasand butonul "+".</p>  <p>Nota: puteti sa programati automat acelasi program zilnic DOAR CAND numarul zilei care doriti sa o ajustati este afisat (asa cum se arata in imagine), DAR NU atunci cand este afisata ora.</p>
<p>Odata ce ultima zi (ZIUA) a fost setata, apasati butonul "+" pentru a termina sesiunea de programare.</p> 		<p>END (SFARSIT) va aparea pe ecran. O alta apasare a butonului "+" va confirma programul ales de d-vs.</p>
<p>"OK" va aparea pe ecran pentru 5 secunde, confirmand ca sesiunea de programare a fost incheiata cu succes. Sistemul este acum programat sa moduleze temperatura conform noilor modificari ale programului P1.</p>		<p>Nota: este posibil sa iesiti oricand din sesiunea de programare fara a afisa fiecare ora pana la ZIUA 7, pentru aceasta tineti apasat butonul "F" si apoi apasati butonul "-".</p> 
<p>N.B.:</p> <ul style="list-style-type: none"> - Puteti abandona sesiunea de afisare/modificare in orice moment, anuland orice setari ce nu au fost salvate, doar prin apasarea butonului "Stand-By" (A). - Restaurarea setărilor implicite va sterge orice setare a Programului P1 creata anterior. (vezi paragraful 6.3) - Daca timp de 90 de secunde, nu se apasa nici un buton, in timpul sesiunii de programare, va avea ca rezultat anularea procedurii de afisare/modificare si se va reintoarce la setarile implicite din fabricatie. - In timpul procesului de programare, elementele de incalzire vor intra automat in modul Stand-By si radiatorul nu va incalzi. 		

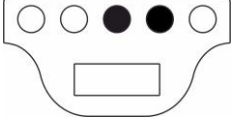

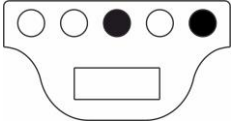
EXEMPLU: CUM SA SETEZI UN PROGRAM PERSONALIZAT

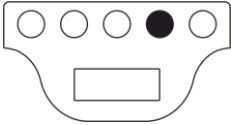





Haideti sa vedem cum programam un aparat nou si anticipam trecerea de la temperatura ECO la CONFORT cu o ora inainte (06:00 a.m. este setarea din fabricatie), pentru fiecare zi incepand de luni pana vineri.

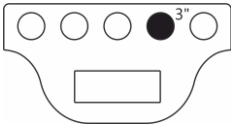

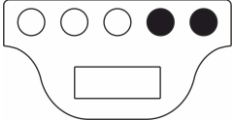
<p>Apasati "M" pentru a alege programul P1</p>		
<p>Setati ziua curenta a saptamanii (prima utilizare a radiatorului), prin apasarea butoanelor "+" sau "-".</p>		
<p>Apasati "M" si setati ora curenta (prima utilizare a radiatorului) prin apasarea butoanelor "+" sau "-".</p>		
<p>Apasati "M" si setati minutul curent (prima utilizare a radiatorului) prin apasarea butoanelor "+" sau "-".</p>		
<p>Apasati "M" pentru a incheia procedura de programare. Acum sistemul se intoarce la programul P1.</p>		
<p>Tineti apasat "-" pentru 3 sec. Pentru a introduce afisarea/modificarea ZILEI 1.</p>		
<p>Apasati "+" pana vedeti H:05 pe ecran (aceasta este ora la care dorim sa modificam temperatura ECO la CONFORT)</p>		
<p>Apasati "M" de 2 ori pentru a schimba nivelul de temperatura de la ECO la CONFORT.</p>		

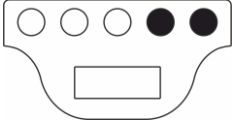
<p>Apasati butonul "+" pana va apare pe ecran D:2 (Marti)</p>		
<p>Pentru a copia acelasi program al ZILEI 1 si in ZIUA 2 tineti apasat butonul "F" si apoi butonul "+" . sistemul va prelua automat programul si va afisa direct ZIUA 3 (Miercuri).</p>		
<p>Repetati procedura descrisa anterior pana cand este afisat pe ecran D:6.</p>		
<p>Din moment ce nu doriti să modificați ZIUA 6 si 7, putem iesi din modul de programare prin tinerea apasata a butonului "F" si apoi apasarea butonului "END" (SFARSIT) va apare pe ecran.</p>		
<p>Apasati "+" pentru confirmarea procesului de modificare. "OK" va palpai pe ecran timp de 5 secunde.</p>		

6.3 Functii speciale

<p>Apasand repetat butonul "F" face posibila alegerea diferitelor functii speciale in sesiunea de programare.</p>		<p>Pentru a iesi din meniul cu functii speciale, asteptati doar 12 sec. Sau apasati butonul "M" pentru a va intoarce la afisarea modului de operare.</p> 
<p>Revenirea la setarile implicite</p>		<p>Pentru a reveni la parametrii impliciti ai radiatorului setati de fabricant, tineti apasat pentru cel puțin 3 sec. butonul "+"</p> 

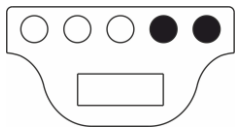
<p>Senzor de prezenta</p> <p>Aceasta functie permite radiatorului sa detecteze daca sunt sau nu persoane in incapere, si automat sa isi moduleze nivelul temperaturii, pentru un consum cat mai redus si asigurarea unei temperaturi confortabile.</p> <p>Pentru mai multe detalii vezi paragraful 6.3.1.</p>		<p>Comutarea functiei (ON) sau (OFF) se face prin apasarea butoanelor "+" sau "-".</p>  <p>Activarea este indicata de aparitia pe ecran a simbolului .</p>
<p>Senzor fereastră deschisa</p> <p>Aceasta functie face posibila detectia ferestrei deschise si va activa automat modul de operare ANT-INGHET.</p> <p>Pentru mai multe detalii vezi paragraful 6.3.2.</p>		<p>Comutarea functiei (ON) sau (OFF) se face prin apasarea butoanelor "+" sau "-".</p>  <p>Activarea este indicata de aparitia pe ecran a simbolului .</p>
<p>Consum zilnic</p> <p>Aceasta functie da posibilitatea se a vizualiza cantitatea de energie electrica pe care radiatorul a consumat-o in ultimele 24 de ore.</p>		<p>Daca indicatorul de consum palpaie, aceasta inseamna ca datele salvate se refera la o perioada mai scurta de 24 de ore.</p> <p>Observatie: ecranul arata consumul estimat, care este posibil sa difere de cel dat de un aparat special de masurare.</p>
<p>Consumul saptamanal</p> <p>Aceasta functie da posibilitatea se a vizualiza cantitatea de energie electrica pe care radiatorul a consumat-o in decurs de 7 zile.</p>		<p>Daca indicatorul de consum palpaie, aceasta inseamna ca datele salvate se refera la o perioada mai scurta de 7 zile.</p> <p>Observatie: ecranul arata consumul estimat, care este posibil sa difere de cel dat de un aparat special de masurare.</p>
<p>Afisare temperatura ambientala</p>		<p>Ecranul arata temperatura ambientala masurata de radiator.</p>

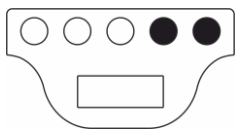
<p>Alinierea temperaturii ambientale</p> <p>Aceasta functie este folosita pentru a modifica temperatura ambientala masurata de radiator si folosita pentru a regla puterea de incalzire, daca necesita corectie pentru a compensa erorile datorate lucrurilor sau curentilor de aer rece din apropierea aparatului.</p>		<p>Pe ecran palpaie valoarea de corectie care va fi aplicata. Pentru editare apasati butoanele "+" or "-".</p>  <p>Daca de exemplu temperatura setata pe radiator este de 19,2°C si temperatura ambientala masurata este de 19,5°C, alinaiati cu +0,3°C</p> <p> Intotdeauna asteptati cel putin 4 ore pentru ca temperatura sa se stabilizeze, inainte sa mai faceti vreo aliniere.</p>
<p>Functia telecomanda</p> <p>Aceasta functie permite radiatorului sa fie controlat utilizand programatoare externe, prize controlate GSM sau dispozitive similare.</p> <p>Pentru mai multe detalii vezi paragraful 6.3.3.</p>		<p>Comutarea functiei (ON) sau (OFF) se face prin apasarea butoanelor "+" sau "-"</p>  <p>AVERTIZARE: activarea nu este indicata de nici o iconita pe ecran.</p>

6.3.1 Senzor de prezenta

Aceasta functie permite radiatorului sa detecteze daca sunt sau nu persoane in incapere si automat sa isi moduleze nivelul temperaturii, pentru un consum cat mai redus si asigurarea unei temperaturi confortabile.

Datorita acestei functii, care poate fi activata doar in modul CONFORT, radiatorul monitorizeaza constant incaperea si daca nu detecteaza persoane isi reduce temperatura de confort dupa cum urmeaza:

Perioada de absenta	Reducerea temperaturii de Confort	Indicatii pe ecran
60 min	1,0°C	Simbolurile senzorului de prezenta si modulului Confort palpaie impreuna. 
90 min	2,0°C	
120 min	3,5°C	
38 ore	Anti-inghet activat 7±3°C	

Reducerea temperaturii se raporteaza intotdeauna la temperatura de CONFORT. Daca radiatorul este in modul ECO sau ANTI_INGHET nu se va observa nici o schimbare a temperaturii de mentinere in incapere.

Daca o persoana va fi detectata in incapere pentru cel putin 10 minute consecutive, temperatura se va intoarce la modul confort setat, fara nici o reducere. La fel se intampla daca, in timp ce temperatura ceruta este redusa datorita absentei persoanelor in incapere, atunci tasta "M" este apasata.

Important:

operarea corecta a acestei functii poate depinde de locul unde radiatorul este pozitionat in camera. Pentru a alege cea mai buna pozitie de instalare, luati in considerare ca senzorul vede orice miscare intr-o arie indicata in figura 9 de mai jos si ca nici un obiect nu trebuie sa fie in raza. Senzorul de prezenta este eficient atunci cand persoanele se misca in fata lui sau inspre el.

6.3.2 Senzor fereastră deschisa

Aceasta functie face posibila detectia ferestrei deschise si va activa automat modul de operare ANTI_INGHET.

Daca detecteaza o schimbare brusca de temperatura in timp ce aparatul functioneaza, modul ANTI_INGHET se va activa automat pentru a reduce pierderea de energie. Pe ecran va fi afisata o fereastră si simbolul ANTI_INGHET palpaind impreuna, in timp ce simbolul pentru modul de funcționare setat de utilizator rămâne.

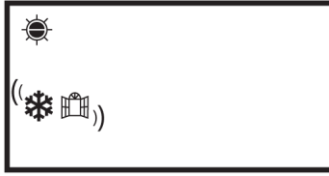

Repornirea functionarii normale nu se face automat, ci prin apasarea butonului "M".

Important:

Functionarea corecta a acestei functii poate depinde de locul unde este pozitionat aparatul in incapere, de prezenta mobilierului, temperatura exterioara si cat timp sta fereastră deschisa.

6.3.3 Functia telecomanda

Aceasta functie permite radiatorului sa fie controlat utilizand programatoare externe, prize controlate GSM sau dispozitive similare. Aceasta functie este activa, daca radiatorul nu este alimentat cu energie electrica mai mult de 30 de minute, cand este comutat in modul stand-by, atunci modul Confort porneste imediat. Astfel, temperatura de confort este activata ca si inainte de intreruperea alimentarii. Senzorul de prezenta (optional) si senzorul de fereastră deschisa sunt dezactivate. Aceasta inseamna ca radiatorul poate porni fara a fi prezent in incapere.

6.4 Utile

Blocare butoane

Butoanele radiatorului pot fi blocate pentru a preveni ca setarile sa fie modificate accidental sau de persoane neavizate. Pentru activare mergeti la modul lock/unlock (inchis/deschis), tineti apasat butonul "F",

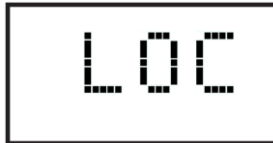
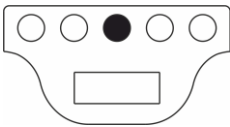

Pe ecran apare "LOC" (inchis):
tineti apasat butonul "F" si apasati tasta "+" pentru a bloca consola de comanda.

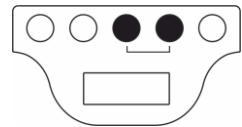

activarea este indicata de simbolul care apare pe ecran 

tineti apasat butonul "F" si apasati tasta "-" pentru a debloca consola de comanda.



Cand aceasta functie este activata, in cazul in care curentul revine dupa o intrerupere de peste 30 min, este reluat modul de functionare setat inainte de intrerupere. Daca modul de functionare a fost unul din cele trei programe P1, P2 sau P3, functionarea va fi reluata pe programul anti-inghet, deoarece vor trebui reintroduse data si ora inainte de folosirea unuia din cele trei programe.

7. Depanare

Problema	Solutie
Radiatorul nu porneste.	Verificati daca sursa de energie este pornita si ca este asa cum indica placutele radiatorului (e.g. 230 Vac 50 Hz) si intrerupatorul principal este pornit pe pozitia I.
Radiatorul nu se incalzeste	Asigurati-va ca functioneaza pe modul dorit daca utilizati un program presetat. Daca temperatura ambientala este mai mare decat cea setata, radiatorul nu ar trebui sa se incalzeasca. Daca nu sunteti sigur, setati modul CONFORT si temperatura doritamai mare decat cea din incapere, pentru a verifica daca radiatorul functioneaza corect.
Radiatorul ramane fierbinte	Verificati ca temperatura nu este prea mare sau ca nu sunt obstacole langa radiator care ar putea altera temperatura ambientala masurata.
Radiatorul nu incalzeste suficient	Verificati ca temperatura setata nu este prea mica si ca aparatul incalzeste incaperea pentru care a fost destinat (tineti usile inchise) . Verificati alimentarea cu energie sa se faca corect.
Radiatorul incalzeste in modul Eco.	Radiatorul se poate incalzi pentru a ajunge / mentine temperatura ECO. Nu este o functionarea anormala.
Suprafata radiatorului este foarte fierbinte.	Este normal sa fie fierbinte in timpul functionarii. Valoarea maxima se incaderaza la limitele date de normele de siguranta. Daca radiatorul este intotdeauna foarte fierbinte, este posibil sa fie subdimensionat pentru incaperea in care este folosit sau poate fi afectata functionarea lui de obstacole.
Temperatura din camera difera de temperatura setata	Asteptati ca temperatura ambientala sa se stabilizeze, cel putin 4 ore si apoi puteti modifica temperatura pentru a compensa intre temperatura aratata de radiator si cea masurata in camera. Vedeti paragraful 6.3 sectiunea alinierea temperaturii ambientale”.
Radiatorul emana un miros neplacut	Atunci cand radiatorul este nou, este posibil ca la prima utilizare sa degaje un miros neplacut, datorat unor reziduri din procesul de fabricatie. Radiatoarele care au fost deja utilizate degaja miros neplacut daca nu sunt utilizate o perioada mai lunga si/sau sunt folosite in spatii poluate sau incaperi cu aerisire slaba.

8. Intretinere

-Acest produs nu necesita intretinere speciala.

-Curatati produsul cu o carpa uscata odata la 6 luni.

-Daca produsul necesita reparatie, contactati un centru autorizat de service.

-Cand inlocuiti cablul de alimentare, utilizati tipul 2x1,00 mm² o 3x1,00mm² H05V2V2-F HAR. Aceasta operatiune trebuie

facuta de personal autorizat si niciodata de utilizator, in acest fel evitandu-se deteriorarea aparatului si pericolul sigurantei personale.

9. Norme legale



Mediul inconjurator si reciclarea

Pentru a contribui la protectia mediului, va cerem sa colectati in mod corect materialele utilizate pentru ambalare.

Dezmembrarea aparatelor uzate

Aparatele care poarta semnul evidentiat in partea dreapta nu trebuie aruncate impreuna cu deseurile menajere, ele trebuie colectate si dezmembrate separat. Dezmembrarea si colectarea aparatelor uzate se va face in conformitate cu legile in vigoare.

RO - Cerințe privind informațiile referitoare la aparatele electrice pentru încălzire locală

Identificatorul de model(e): KLIMA					
Parametru	Simbol	Valoare	Unitate	Parametru	Unitate
Puterea termică				Modul de acumulare a căldurii, numai în cazul aparatelor electrice pentru încălzire locală cu acumulator de căldură (alegeți o variantă)	
Puterea termică nominală	P_{nom}	(*) vezi Tab. 1	kW	control manual al sarcinii termice, cu termostat integrat	nu
Puterea termică minimă (cu titlu indicativ)	P_{min}	(*) vezi Tab. 1	kW	control manual al sarcinii termice, ca răspuns la temperatura camerei și/sau exterioară	nu
Puterea termică maximă continuă	$P_{max,c}$	(*) vezi Tab. 1	kW	control electronic al sarcinii termice, ca răspuns la temperatura camerei și/sau exterioară	nu
Consumul auxiliar de energie electrică				putere termică comandată de ventilator	nu
La putere termică nominală	e_{lmax}	0,000	kW	Tip de putere termică/controlul temperaturii camerei (selectați o variantă)	
La putere termică minimă	e_{lmin}	0,000	kW	cu o singură treaptă de putere termică și fără controlul temperaturii camerei	nu
În modul standby	e_{lsb}	0,00025	kW	două sau mai multe trepte de putere manuale, fără controlul temperaturii camerei	nu
				cu controlul temperaturii camerei prin intermediul unui termostat mecanic	nu
				cu control electronic al temperaturii camerei	nu
				cu control electronic al temperaturii camerei și cu temporizator cu programare zilnică	nu
				cu control electronic al temperaturii camerei și cu temporizator cu programare săptămânală	da
				Alte opțiuni de control (se pot selecta mai multe variante)	
				controlul temperaturii camerei, cu detectarea prezenței	da
				controlul temperaturii camerei, cu detectarea unei ferestre deschise	da
				cu opțiune de control la distanță	nu
				cu demaraj adaptabil	nu
				cu limitarea timpului de funcționare	nu
				cu senzor cu bulb negru	nu
Date de contact	Ermete Giudici S.p.A. - via L. da Vinci 27 - 20090 Segrate (MI) Italia				

Tabelul 1		KLIMA 7 KLIMA 7 AS	KLIMA 10	KLIMA 15	KLIMA 20
Puterea termică					
Puterea termică nominală	P_{nom}	0,750	1,000	1,500	2,000
Puterea termică minimă (cu titlu indicativ)	P_{min}	0,075	0,113	0,150	0,188
Puterea termică maximă continuă	$P_{max,c}$	0,750	1,000	1,500	2,000

GEBRUIKSINSTRUCTIES

Lees deze instructies zorgvuldig door voordat u de radiator gebruikt. Zo voorkomt u schade en gevaarlijke situaties. Enig gebruik anders dan beschreven in deze handleiding kan brand, elektrische schokken of letsel veroorzaken en leidt ertoe dat de garantie vervalt.

De garantie geldt niet voor eventuele defecten, verslechtering, verlies, letsel of schade veroorzaakt door of als gevolg van het verkeerd gebruik of misbruik van deze radiator. Aan rechten die voortvloeien uit nationale wetgeving wordt geen afbreuk gedaan. Geen van de garantiebepalingen vormt een uitsluiting van voorwaarden of garanties vastgelegd in nationale wetgeving, die niet uitgesloten of gewijzigd kunnen worden.

Verwijder vóór het gebruik de verpakking en controleer of het apparaat intact is. Neem in geval van defecten of schade contact op met de dealer. Probeer het apparaat niet zelf te repareren.

Laat kinderen niet met de verpakking spelen en bescherm het milieu door de verpakking overeenkomstig de nationale voorschriften voor afvalverwerking te verwijderen.

1. Voor uw veiligheid

- ❑ Dit apparaat is bedoeld voor normaal huishoudelijk gebruik en niet voor gebruik in voertuigen of aan boord van schepen of vliegtuigen.
- ❑ Dit apparaat kan worden gebruikt door kinderen vanaf 8 jaar en personen met verminderde lichamelijke, zintuiglijke of verstandelijke vermogens of een gebrek aan ervaring en kennis, mits ze onder toezicht staan of instructies hebben gekregen over hoe ze het apparaat op een veilige manier kunnen gebruiken en de risico's begrijpen. Kinderen mogen niet met het apparaat spelen. Reiniging of onderhoud mag niet door kinderen worden uitgevoerd, tenzij onder toezicht.
- ❑ Kinderen jonger dan 3 jaar moeten uit de buurt van het apparaat worden gehouden, tenzij er voortdurend toezicht is.
- ❑ Kinderen tussen de 3 en 8 jaar mogen het apparaat alleen in-/uitschakelen indien het op de beoogde, normale plek van gebruik is geplaatst of geïnstalleerd, mits ze onder toezicht staan of instructies hebben gekregen over hoe ze het apparaat op een veilige manier kunnen gebruiken en de risico's begrijpen. Kinderen tussen de 3 en 8 jaar mogen het apparaat niet aansluiten, regelen of schoonmaken, of onderhoud eraan plegen.
- ❑ **LET OP: Sommige delen van dit apparaat kunnen zeer heet worden en brandwonden veroorzaken. Let vooral op wanneer kinderen en kwetsbare personen aanwezig zijn.**
- ❑ Zorg ervoor dat de netvoeding overeenkomt met de nominale voedingsspanning: 230 V AC, 50 Hz.
- ❑ Laat kinderen niet met het apparaat spelen en zorg ervoor dat kinderen en dieren het niet aanraken. Let op! Het paneel kan tijdens gebruik zeer heet worden (circa 80 °C);

- ❑ **WAARSCHUWING: Om oververhitting te voorkomen, mag de radiator niet worden bedekt.** Hang geen voorwerpen over de radiator en bedek het apparaat niet terwijl het in gebruik is. Dit wordt duidelijk op het apparaat vermeld of aangegeven door het symbool



- ❑ Gebruik het apparaat niet in ruimtes met explosieve gassen, dampen van oplosmiddelen of verf, of ontvlambare dampen/gassen.
- ❑ Repareer een beschadigde kabel en/of stekker niet zelf, maar breng het apparaat naar de technische dienst of een erkend reparatiecentrum en laat het repareren door gespecialiseerd personeel om het risico op beschadiging te voorkomen.
- ❑ Plaats het apparaat zodanig dat de stekker altijd bereikbaar is.
- ❑ Het apparaat mag niet direct onder of voor een stopcontact worden geplaatst.
- ❑ Steek geen objecten of papier in de radiator.

2. Het product

- ❑ Naast de door u gekozen radiator bevat het pakket het volgende (afbeelding 1):
 - N° 1 metalen beugel voor wandmontage (bevestigd aan de radiator);
 - N° 4 nylon muurplugs 8 x 50 mm;
 - N° 4 kruiskopschroeven 5 x 60 mm voor bevestigen van muurbeugel;
- ❑ Neem contact op met uw dealer als iets kapot is of ontbreekt.

3. Veilige positionering

- ❑ Gebruik het apparaat alleen in de horizontale positie; tegen een verticale wand;
- ❑ Het beschikt over een dubbele elektrische isolatie (klasse II) en heeft daarom geen aardverbinding nodig;
- ❑ Neem de minimumafstanden tot muren, meubels en/of objecten in acht (zie afbeelding 2).
- ❑ Installeer het apparaat niet op een oppervlak van hout of synthetisch materiaal.
- ❑ Het apparaat is waterbestendig (IP24). Het kan daarom in badkamers of andere vochtige ruimtes worden gebruikt, mits het niet in de zone van badkuipen of douches wordt geïnstalleerd (volume 1, afbeelding 3).
- ❑ Installeer de radiator niet op een tochtige plek; dit kan de regeling beïnvloeden.

4. Installatie

- ❑ Verwijder de wandmontagebeugel aan de achterkant van de radiator door eerst de 2 bovenste veren en vervolgens de 2 onderste veren (zie afb. 4) in te drukken.
- ❑ Plaats de beugel op de vloer en gebruik hem als sjabloon om de plek te markeren waar de twee onderste bevestigingsgaten gemaakt moeten worden (afb. 5A).
- ❑ Til de beugel op totdat de onderste bevestigingspunten overeenkomen met de gemaakte markeringen en gebruik een potlood om de plek van de twee bovenste bevestigingsgaten te markeren (afb. 5B).
- ❑ Boor de 4 gaten op de gemarkeerde plekken en steek de muurpluggen in (afb. 6).
- ❑ Bevestig de beugel aan de muur met behulp van de 4 meegeleverde schroeven (afb. 7).
- ❑ Hang de radiator op de beugel, beginnende met de 2 onderste bevestigingspunten, en klik vervolgens de 2 bovenste bevestigingspunten in positie (afb. 8).
- ❑ Indien de radiator op een later tijdstip van de beugel moet worden gehaald, bevelen wij aan eerst de onderste twee bevestigingspunten los te klikken en daarna de bovenste.

5. Elektrische aansluitingen

- ❑ Het apparaat moet worden gevoed met een spanning van 230 V AC, 50 Hz.
- ❑ Het apparaat moet met een kabel en stekker of met een installatiekabel worden geleverd. Indien een apparaat met stekker in Frankrijk wordt geïnstalleerd, dient de stekker te worden afgesneden en het apparaat via een geschikte aansluitdoos op de netvoeding te worden aangesloten.
- ❑ Installeer de aansluitterminal in badkamers, keukens of andere vochtige ruimtes ten minste 25 cm boven de vloer.

- De elektrische aansluiting op de netvoeding moet tevens een 2-polige schakelaar met een minimale contactopening van 3 mm omvatten. Leef altijd de nationale bekabelingsvoorschriften na.

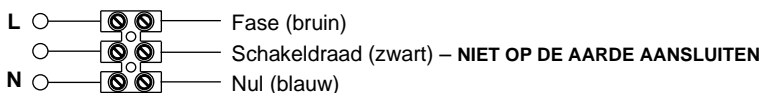

6. Het apparaat gebruiken

6.1 Beschrijving van de knoppen

- A – Aan-uitknop/standby
- B – Modusknop
- C – Speciale functies
- D – Verhogen/activeren
- E – Verlagen/deactiveren
- F – Display
- G – Hoofdschakelaar

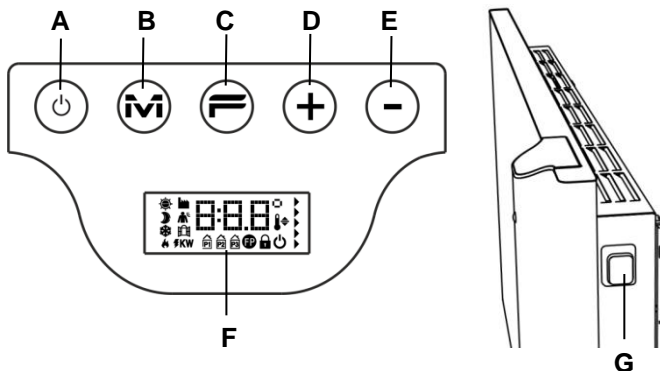

6.2 Bediening

6.2.1 Het display inschakelen

Indien het display niet ingeschakeld is, moet u op een knop drukken om het op te laten lichten.
Het display licht op en blijft 30 seconden geactiveerd nadat voor het laatst een knop is ingedrukt.

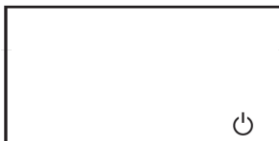

Als het display uitgeschakeld is, licht het de eerste keer dat een knop is ingedrukt op zonder de functie van de desbetreffende knop te activeren.





6.2.2 De radiator in-/uitschakelen

De stroomtoevoer naar de radiator wordt geregeld middels een 2-polige elektromechanische schakelaar (G) aan de rechterzijde van de radiator. Als deze schakelaar wordt gebruikt, wordt de stroomtoevoer naar de printplaat uitgeschakeld. Als gevolg hiervan gaan na circa 30 minuten alle opgeslagen parameters verloren en worden de standaardinstellingen teruggezet.

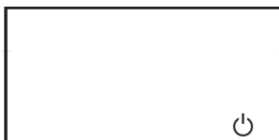
Wij raden aan deze schakelaar alleen te gebruiken als de radiator lange tijd niet zal worden gebruikt. Druk op de Aan-uit-/standby-knop (A) om de radiator korte periodes uit te schakelen. Zo voorkomt u dat de instellingen verloren gaan.

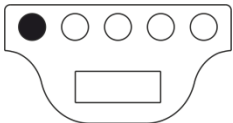

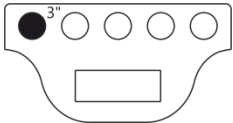



Als de radiator door middel van de hoofdschakelaar aan de zijkant wordt ingeschakeld, licht het display op en wordt het standby-symbool weergegeven.







<p>Druk voor het inschakelen van de radiator op de Aan-uit-/standby-knop.</p> 		<p>De radiator begint altijd in de comfort-modus. Indien de radiator nieuw is of de stroomtoevoer langer dan 30 minuten is uitgeschakeld, staat de comforttemperatuur op de standaardwaarde (19 °C).</p>
<p>Om de radiator uit te uitschakelen, moet u de Aan-uit-/standby-knop ten minste 3 seconden ingedrukt houden.</p> 		<p>Als u de radiator uitschakelt met de schakelaar aan de zijkant, gaan na 30 minuten alle opgeslagen gegevens verloren (datum, tijd, temperatuurstellingen, etc.).</p>



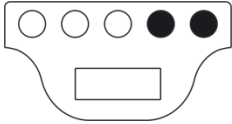



6.2.3 De modus kiezen

<p>Door herhaaldelijk op de "M"-knop te drukken, kunt u de gewenste modus kiezen.</p> 		<p>De modi worden in de volgende volgorde geactiveerd:</p>  <p>Dertig seconden nadat de "M"-knop is ingedrukt, begint de activeringsvolgorde van de modi weer vanaf het begin, zodat vanuit een willekeurige modus sneller naar de Comfort-modus kan worden geschakeld.</p>
---	---	---

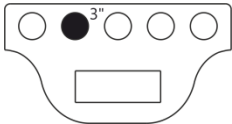
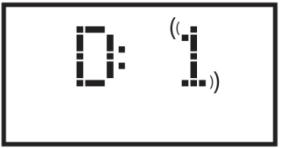
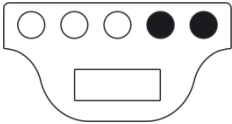
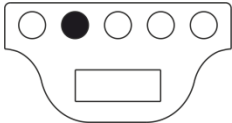
Icoontje	Beschrijving	Wanneer gebruikt
	Comfort	Als u thuis bent. De radiator handhaaft de ingestelde temperatuur.
	Eco	Als u korte tijd van huis bent (van 2 tot 48 uur) of als u slaapt. De radiator handhaaft de ingestelde eco-temperatuur en bespaart energie.
	Antivorst	Als u lange tijd van huis bent (meer dan 48 uur). De temperatuur wordt automatisch ingesteld op 7±3 °C en kan niet worden veranderd.
	Programma P1	Als u vooraf ingestelde programma's wilt, geschikt voor diegenen die niet thuis werken. DIT PROGRAMMA KAN TEVENS WORDEN AANGEPAST (ZIE DE INSTRUCTIES IN PARAGRAAF 6.2.6.).
	Programma P2	Als u vooraf ingestelde programma's wilt, geschikt voor vakantiewoningen die in het weekend worden gebruikt.
	Programma P3	Als u vooraf ingestelde programma's wilt, geschikt voor kantoren en werkplekken.
	Schakeldraad	Als u de werking van de radiator controleert aan de hand van een externe regelunit met een schakeldraad. (niet van toepassing)

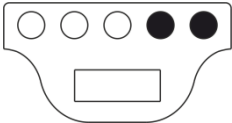
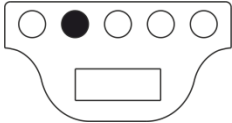
<p>De vooraf ingestelde eco-temperatuur is 15,5 °C en kan met de "+"- of "-"-knop worden gewijzigd.</p> 		<p>Het aanbevolen verschil tussen de comfort- en eco-temperatuur is 3,5 °C. Als het ingestelde verschil afwijkt van de voorgestelde waarde, verandert het eco-symbool als volgt:</p>  <p>De maximale waarde die voor de eco-temperatuur kan worden ingesteld, is gelijk aan de comforttemperatuur - 0,5 °C.</p>
<p>Indien de kamertemperatuur lager is dan de gewenste en weergegeven temperatuur, verschijnt de verwarmingsindicator  op het display.</p>		

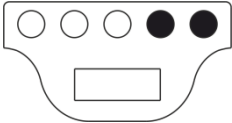
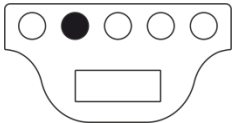
6.2.5 De dag en tijd instellen

<p>De dag en tijd worden ingesteld om gebruik te kunnen maken van de drie vooraf ingestelde programma's. Houd hiervoor de modusknop ingedrukt.</p> 		<p>De in te stellen dag begint te knipperen (1 = maandag). Druk op de "+"- of "-"-knop om deze te wijzigen.</p> 
<p>Druk op de modusknop om de dag te bevestigen en verder te gaan naar het instellen van de tijd.</p> 		<p>Op het display begint de uurwaarde te knipperen. Druk op de "+"- of "-"-knop om deze te wijzigen.</p> 
<p>Druk op de modusknop om de uurwaarde te bevestigen en verder te gaan naar het instellen van de minuten.</p> 		<p>Op het display beginnen de minuten te knipperen. Druk op de "+"- of "-"-knop om deze te wijzigen.</p> 
<p>Druk op de modusknop om de minuten te bevestigen en het instellen te beëindigen.</p> 		<p>Het systeem keert terug naar de modus die geactiveerd was voordat u met instellen begon.</p> <p>Als u probeert een vooraf ingesteld programma te activeren zonder dat u de datum en tijd heeft opgeslagen, wordt deze instellingsprocedure automatisch geactiveerd.</p>







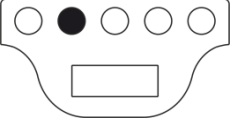

6.2.6 Programma P1 wijzigen

Het programma P1 kan aan de behoeften van gebruikers worden aangepast. Door P1 te wijzigen, kunt u de gewenste kamertemperatuur, instellen, waarbij u keuze heeft uit Comfort, ECO of Vorstvrij, voor elk uur van de dag en voor de hele week.

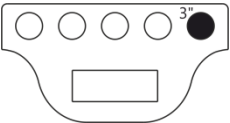
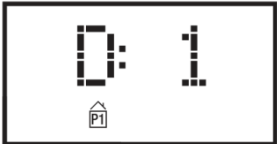
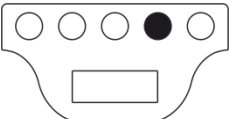
Zie paragraaf 6.2.4 voor het instellen van de temperaturen voor elke modus.

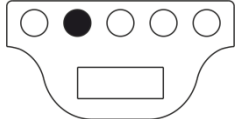
Elk weergegeven uur van de dag toont de momenteel ingestelde temperatuur van programma P1. Indien de radiator voor het eerst wordt gebruikt, verwijzen wij u naar paragraaf 6.2.3.1 voor het ingestelde profiel van P1.

Als u programma P1 wilt weergeven of wijzigen, moet u het volgende doen:

<p>Druk op "M" om programma P1 te kiezen.</p> 		<p>Indien de tijd nog niet is ingesteld (nieuw product, of langer dan 30 min. geen stroomtoevoer), wordt de procedure voor het instellen van de tijd automatisch geactiveerd (zie paragraaf 6.2.5)</p>
<p>Houd de "-"-knop 3 seconden ingedrukt om programma P1 op te roepen.</p> 		<p>De eerste weer te geven/aan te passen dag wordt nu getoond (1 = maandag)</p>
<p>Druk op de "+"-knop om het eerste weer te geven/aan te passen uur in te stellen.</p> 		<p>Druk op de "M"-knop om de gewenste temperatuur te kiezen (keuze uit Comfort, Eco of Vorstvrij):</p>   <p>De temperatuur die wordt weergegeven nadat u een specifiek uur heeft gekozen, is de temperatuur die momenteel voor programma P1 is ingesteld.</p>
<p>Gebruik de "+"- en "-"-knoppen om elk uur van dag 1 in te stellen en de temperatuur voor elk uur te zien/te wijzigen.</p> 		<p>Het weergegeven uur duidt altijd op het startpunt. Bijvoorbeeld: als H 23 wordt weergegeven, heeft de wijziging betrekking op de periode tussen 23.00 en 0.00.</p>

Indien u de temperatuur voor elk van de 24 uren van Dag 1 heeft aangepast, drukt u op de "+"-knop om naar de wijzigingsmodus voor Dag 2 te gaan.

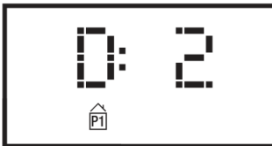
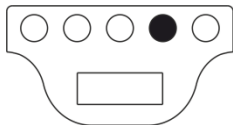

Druk op de "+"-knop om de temperatuur voor elk uur van Dag 2 weer te geven/aan te passen, zoals beschreven voor Dag 1.

U kunt het programma van Dag 1 automatisch voor Dag 2 gebruiken door de "F"-knop ingedrukt te houden en op de "+"-knop te drukken.

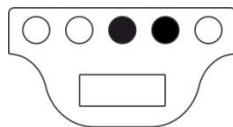

Opmerking: u mag hetzelfde dagprogramma ALLEEN kopiëren en plakken WANNEER het cijfer van de dag die u wilt wijzigen, wordt weergegeven (zie afbeelding) - EN NIET wanneer het uur wordt weergegeven.

Als de laatste dag (Dag 7) is ingesteld, drukt u op de "+"-knop om de programmeerprocedure te beëindigen.

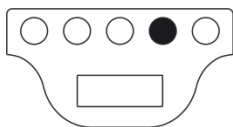

END verschijnt op het display. Door nog een keer op de "+"-knop te drukken, bevestigt u het gewijzigde programma.

"OK" verschijnt gedurende 5 seconden op het display, als bevestiging dat de programmeerprocedure succesvol is uitgevoerd. Het systeem is nu ingesteld om de temperatuur aan te passen overeenkomstig het gewijzigde programma P1.



Opmerking: u kunt de programmeerprocedure op elk moment verlaten, zonder elk uur tot Dag 7 weer te geven.

Houd hiervoor de "F"-knop indrukt en druk op de "-"-knop.

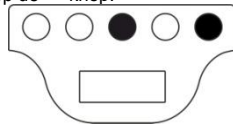









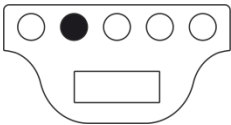

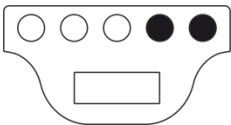
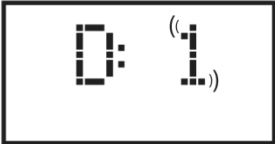
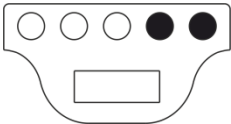

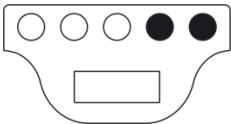

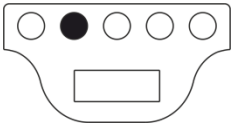

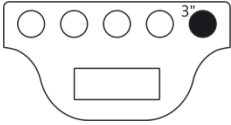

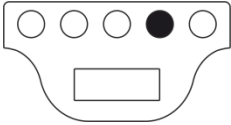

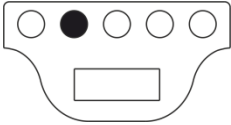

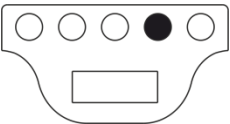

N.B.:

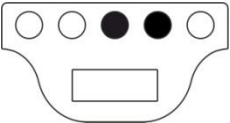
- U kunt de display-/wijzigingsprocedure op elk moment afbreken door op de "Standby"-knop te drukken. Alle niet-opgeslagen instellingen worden dan verwijderd.
- Het herstellen van de standaardinstellingen leidt ertoe dat elk eerder aangemaakt P1-programma wordt verwijderd (zie paragraaf 6.3);
- Indien tijdens het instellen van het programma 90 seconden lang geen knop wordt ingedrukt, wordt de display-/wijzigingsprocedure afgebroken en worden de standaard fabrieksinstellingen hersteld;
- De verwarmingselementen worden tijdens de programmeerprocedure automatisch in de standby-modus geschakeld. De radiator verwarmt dan niet.

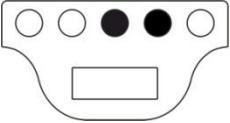

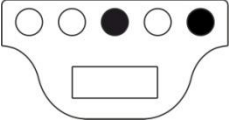

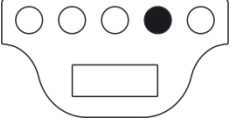
VOORBEELD: EEN AANGEPAST PROGRAMMA INSTELLEN





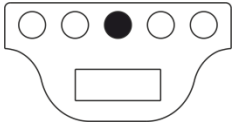

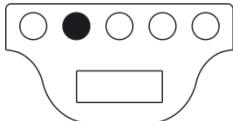

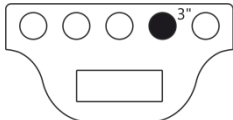
In het onderstaande wordt beschreven hoe u een nieuwe radiator kunt programmeren, en 1 uur eerder op de verandering van ECO- naar COMFORT-temperatuur kunt anticiperen (06.00 uur is de standaard fabrieksinstelling), voor elke dag van maandag tot vrijdag.



<p>Druk op "M" om programma P1 te selecteren</p>		
<p>Stel de huidige dag van de week in (eerste gebruik van de radiator) met de "+"- of "-"-knop.</p>		
<p>Druk op "M" en stel het huidige uur in (eerste gebruik van de radiator) met de "+"- of "-"-knop.</p>		
<p>Druk op "M" en stel de huidige minuten in (eerste gebruik van de radiator) met de "+"- of "-"-knop.</p>		
<p>Druk op "M" om de tijdstellingsprocedure te beëindigen. Het systeem keert nu terug naar programma P1.</p>		
<p>Houd "-" 3 seconden ingedrukt om Dag 1 weer te geven/aan te passen.</p>		
<p>Houd "+" ingedrukt totdat u H:05 op het display ziet (het uur waarvoor we de ECO-temperatuur in COMFORT willen veranderen).</p>		
<p>Druk twee keer op "M" om de ECO-temperatuur te veranderen in COMFORT.</p>		

<p>Houd "+" ingedrukt totdat D:2 op het display verschijnt (dinsdag)</p>		
<p>Om hetzelfde programma van Dag 1 naar Dag 2 te kopiëren en te plakken, houdt u "F" ingedrukt en drukt u op "+". Het systeem kopieert het programma automatisch en geeft direct Dag 3 (woensdag) weer.</p>		
<p>Herhaal de eerder beschreven procedure totdat D:6 op het display verschijnt.</p>		
<p>Aangezien we Dag 6 en 7 niet willen aanpassen, kunnen we de modus Programma-instellingen verlaten. Houd hiervoor "F" ingedrukt en druk op "-". "END" verschijnt op het display.</p>		
<p>Druk op "+" om de wijzigingen te bevestigen. "OK" knippert gedurende 5 sec. op het display.</p>		

6.3 Speciale functies

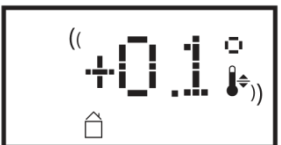
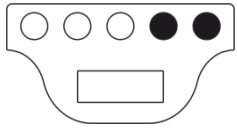

<p>Door herhaaldelijk op de "F"-knop te drukken, kunt u de verschillende speciale functies in volgorde selecteren.</p> 		<p>Om het menu voor speciale functies te verlaten, wacht u 12 seconden of drukt u op de "M"-knop om terug te gaan naar de geactiveerde modus.</p> 
<p>De standaardinstellingen herstellen</p>		<p>Als u de standaardinstellingen (door de fabrikant ingesteld) van de radiator wilt herstellen, moet u de "+"-knop ten minste 3 seconden ingedrukt houden.</p> 

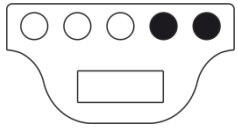
<p>Aanwezigheidssensor</p> <p>Als deze functie geactiveerd is, kan de radiator eventuele personen in de ruimte detecteren. De temperatuur wordt automatisch aangepast om comfort en energiebesparing te optimaliseren.</p> <p>Zie paragraaf 6.3.1 voor meer informatie.</p>		<p>U kunt deze functie inschakelen (ON) of uitschakelen (OFF) door op de "+"-respectievelijk "-"-knop te drukken.</p>  <p>Activering wordt aangeduid door het relevante icoontje  dat op het display verschijnt</p>
<p>Raam open-sensor</p> <p>Deze functie maakt het mogelijk een open raam te detecteren en automatisch de antivorst-modus te activeren.</p> <p>Zie paragraaf 6.3.2 voor meer informatie.</p>		<p>U kunt deze functie inschakelen (ON) of uitschakelen (OFF) door op de "+"-respectievelijk "-"-knop te drukken.</p>  <p>Activering wordt aangeduid door het relevante icoontje  dat op het display verschijnt.</p>
<p>Dagelijks verbruik</p> <p>Deze functie maakt het mogelijk om te zien hoeveel energie de radiator de afgelopen 24 uur heeft verbruikt.</p>		<p>Als de verbruiksindicatie knippert, betekent dit dat de opgeslagen gegevens betrekking hebben op een periode korter dan 24 uur.</p> <p>Let op: Het display toont het geschatte verbruik, dat af kan wijken van het verbruik gemeten door meters die specifiek daarvoor bedoeld zijn.</p>
<p>Wekelijks verbruik</p> <p>Deze functie maakt het mogelijk om te zien hoeveel energie de radiator de afgelopen 7 dagen heeft verbruikt.</p>		<p>Als de verbruiksindicatie knippert, betekent dit dat de opgeslagen gegevens betrekking hebben op een periode korter dan 7 dagen.</p> <p>Let op: Het display toont het geschatte verbruik, dat af kan wijken van het verbruik gemeten door meters die specifiek daarvoor bedoeld zijn.</p>
<p>De kamertemperatuur weergeven</p>		<p>Het display toont de kamertemperatuur die door de radiator is gemeten.</p>

<p>De kamertemperatuur corrigeren</p> <p>Deze functie wordt gebruikt om de door de radiator gemeten kamertemperatuur aan te passen en het verwarmingsvermogen te regelen, om te compenseren voor leesfouten door o.a. de nabijheid tot warmtebronnen of koude luchtstromen.</p>		<p>Op het display knippert de correctiewaarde die moet worden toegepast. Druk op de "+"- of "-"-knop om deze te wijzigen.</p>  <p>Als de op de radiator ingestelde temperatuur bijvoorbeeld 19,2 °C is en de gemeten kamertemperatuur 19,5 °C, is de correctiewaarde +0,3 °C.</p>  <p>Wacht ten minste 4 uur om de temperatuur te laten stabiliseren voordat u een correctie uitvoert.</p>
<p>Regeling op afstand</p> <p>Deze functie maakt het mogelijk de radiator met externe timers, pilootcontacten met telefonische schakeling, en soortgelijke apparaten te regelen.</p> <p>Zie paragraaf 6.3.3 voor meer informatie.</p>		<p>U kunt deze functie inschakelen (ON) of uitschakelen (OFF) door op de "+"- respectievelijk "-"-knop te drukken.</p>  <p>Waarschuwing: Activering wordt NIET aangeduid met een icoontje op het display.</p>

6.3.1 Aanwezigheidssensor

Als deze functie geactiveerd is, kan de radiator eventuele personen in de ruimte detecteren. De temperatuur wordt automatisch aangepast om comfort en energiebesparing te optimaliseren. Deze functie, die alleen in de Comfort-modus kan worden geactiveerd, stelt de radiator in staat voortdurend de ruimte te bewaken. Indien geen personen worden gedetecteerd, wordt de ingestelde comforttemperatuur als volgt verlaagd:

Afwegigheids-duur	Verlaging van comfort-temperatuur	Indicatie op het display
60 min.	1,0 °C	De icoontjes voor de aanwezigheidssensor en comfort-modus knipperen allebei
90 min.	2,0 °C	
120 min.	3,5 °C	
38 uur	Antivorst geactiveerd 7±3 °C	

De temperatuurverlaging heeft altijd betrekking op de comforttemperatuur. Indien de Eco- of Antivorst-modus van de radiator geactiveerd is, wordt de temperatuur in de ruimte niet aangepast.

Als een persoon ten minste 10 opeenvolgende minuten in de ruimte wordt gedetecteerd, wordt de temperatuur automatisch verhoogd naar de comforttemperatuur, zonder enige reductie. Hetzelfde gebeurt als op de "M"-knop wordt gedrukt terwijl de gewenste temperatuur wordt verlaagd omdat er geen personen in de ruimte worden gedetecteerd.

Belangrijk:

De correcte werking van deze functie is afhankelijk van de plek waar de radiator in de ruimte geïnstalleerd is. Bij het kiezen van de beste installatiepositie dient u er rekening mee te houden dat de sensor bewegingen detecteert binnen de zone weergegeven in afb. 9. Er mogen geen objecten voor de sensor staan die de detectie belemmeren. Aanwezigheidsdetectie is bovendien effectiever wanneer personen voor de sensor langs lopen in plaats van ernaartoe.

6.3.2 Raam open-sensor

Deze functie maakt het mogelijk een open raam te detecteren en automatisch de antivorst-modus te activeren. Indien een plotselinge verlaging van de temperatuur wordt gedetecteerd wanneer de radiator normaal functioneert, wordt de antivorst-modus automatisch geactiveerd om energieverstopping te beperken. Op het display knippert zowel het raam- als antivorst-icoontje, terwijl het icoontje voor de modus ingesteld door de gebruiker zichtbaar blijft.

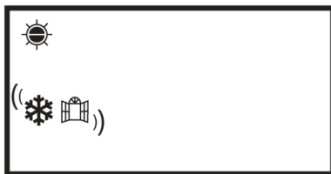

De normale modus wordt niet automatisch hersteld; druk op de "M"-knop om deze te activeren.

Belangrijk:





De correcte werking van deze functie is afhankelijk van de plek waar de radiator in de ruimte geïnstalleerd is, de aanwezigheid van tocht, de buitentemperatuur en hoe lang het raam open blijft.

6.3.3 Regeling op afstand

(n.v.t. advies is deze modus niet te gebruiken, dit is bedoeld voor de Franse installatie markt)

Deze functie maakt het mogelijk de radiator met externe timers, pilootcontacten met telefonische schakeling, en soortgelijke apparaten te regelen. Indien deze functie actief is, start de comfort-modus onmiddellijk nadat de stroomtoevoer hersteld wordt na meer dan 30 minuten onderbroken te zijn geweest. De standby-modus wordt niet ingeschakeld zoals gebruikelijk is. De comforttemperatuur wordt ingesteld op de waarde voordat de stroomtoevoer werd onderbroken. De (optionele) aanwezigheidssensor en raam open-sensor worden gedeactiveerd. Dit betekent dat de radiator ingeschakeld kan worden zonder in de ruimte te zijn.

6.4. Aanvullende mogelijkheden

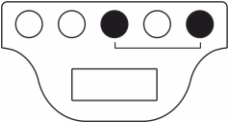
<p>Knoppen vergrendelen</p> <p>De knoppen van de radiator kunnen worden vergrendeld, zodat instellingen niet per ongeluk of door onbevoegde personen kunnen worden gewijzigd. Ga naar de modus vergrendelen/ontgrendelen, houd de "F"-knop ingedrukt.</p> 		<p>Als "LOC" op het display verschijnt:</p> <p>Houd de "F"-knop ingedrukt en druk op de "+"-knop om de knoppen te vergrendelen.</p>  <p>Activering wordt aangeduid door het relevante icoontje  dat op het display verschijnt</p> <p>Houd de "F"-knop ingedrukt en druk op de "-"-knop om de knoppen te ontgrendelen.</p> 
<p>Als deze functie geactiveerd is en de stroomtoevoer hersteld wordt na een onderbreking van langer dan 30 minuten, wordt de modus hersteld die ten tijde van de onderbreking ingesteld was. Indien de bedrijfsmodus een van de drie programma's P1, P2 of P3 was, wordt in plaats daarvan het antivorst-programma geactiveerd, omdat u de tijd en dag moet instellen voordat u opnieuw een programma activeert.</p>		

7. Probleemoplossing

Probleem	Oplossing
De radiator wordt niet ingeschakeld.	Controleer of het apparaat op de netvoeding is aangesloten en of deze overeenkomt met de spanning op het typeplaatje van de radiator (bijv. 230 V AC, 50 Hz), en of de hoofdschakelaar aan de rechterkant ingeschakeld is (positie "I").
De radiator verwarmt niet.	Controleer of de bedrijfsmodus zoals gewenst is en, als u een vooraf ingesteld programma gebruikt, of voor de desbetreffende periode geen antivorst-modus is ingesteld. Indien de kamertemperatuur hoger is dan de ingestelde temperatuur, wordt de radiator niet ingeschakeld. Als u twijfelt, stelt u de comfort-modus en een gewenste temperatuur veel hoger in dan de kamertemperatuur. Zo kunt u controleren of de radiator correct functioneert.
De radiator blijft warm.	Controleer of de ingestelde temperatuur niet te hoog is en of er koude tocht langs de radiator komt. Tocht beïnvloedt de gemeten kamertemperatuur.
De radiator verwarmt niet voldoende.	Controleer of de ingestelde temperatuur niet te laag is, of de radiator alleen de ruimte verwarmt waarin hij geïnstalleerd is (houd deuren gesloten) en of de netvoeding correct is.
De radiator verwarmt in Eco-modus.	De radiator verwarmt tot de eco-temperatuur is bereikt of handhaaft deze temperatuur. Dit is niet ongewoon.
Het oppervlak van de radiator is erg warm.	Het is normaal dat het oppervlak warm is als de radiator aan staat. De maximumwaarden komen overeen met de grenswaarden die vastgelegd zijn in toepasselijke veiligheidsnormen. Indien de radiator altijd erg warm is, is hij niet groot genoeg voor de ruimte waarin hij gebruikt wordt, of is er sprake van tocht.
De temperatuur in de ruimte wijkt af van de temperatuur die is ingesteld.	Als u ten minste 4 uur gewacht heeft om de kamertemperatuur te laten stabiliseren, moet u wellicht eventuele verschillen tussen de door de radiator aangegeven temperatuur en de in de ruimte gemeten temperatuur compenseren. Zie hiervoor paragraaf 6.3, alinea "De kamertemperatuur corrigeren".
De radiator geeft een onaangename geur af.	Als de radiator nieuw is, kan het zijn dat u een onaangename geur ruikt als hij voor het eerst wordt gebruikt. Dit komt door residuen van het productieproces. Radiators die al gebruikt zijn, kunnen onaangename geuren afgeven als ze lange tijd niet zijn gebruikt en/of als ze gebruikt worden in verontreinigde ruimtes met een slechte luchtkwaliteit.

8. Onderhoud

- Dit apparaat vereist geen specifiek onderhoud.
- Maak het apparaat, vooral het verwarmingspaneel, om de zes maanden met een droge doek schoon en stofvrij.
- Indien het apparaat gerepareerd dient te worden, moet u contact opnemen met een erkend technisch servicecentrum.
- Als de kabel vervangen dient te worden, moet een 2 x 1,00 mm²- of 3 x 1,00 mm²-kabel (type H05V2V2-F HAR) gebruikt worden, afhankelijk van de versie. Kabels met of zonder stekker mogen uitsluitend door gekwalificeerd personeel en niet door de eindgebruiker zelf worden vervangen om schade aan het apparaat en persoonlijk letsel te voorkomen.

9. Juridische mededeling



Milieu en recycling

Wij verzoeken u ons bij de bescherming van het milieu behulpzaam te zijn. Verwijder de verpakking daarom overeenkomstig de voor de afvalverwerking geldende nationale voorschriften.

Recycling van oude toestellen

Toestellen met dit kenmerk horen niet thuis in de vuilnisbak en moeten apart worden ingezameld en gerecycled volgens de ter plaatse geldende voorschriften en wetgeving.

NL - Informatie-eisen voor elektrische toestellen voor lokale ruimteverwarming

Typeaanduiding(en): KLIMA					
Item	Symbol	Waarde	Eenheid	Item	Eenheid
Warmteafgifte				Type warmte-input, uitsluitend voor elektrische warmteopslagtoestellen (selecteer één)	
Nominale warmteafgifte	P_{nom}	(*) zie Tab. 1	kW	Handmatige sturing van de warmteopslag, met geïntegreerde thermostaat	neen
Minimale warmteafgifte (indicatief)	P_{min}	(*) zie Tab. 1	kW	Handmatige sturing van de warmteopslag, met kamer- en/of buitentemperatuurfeedback	neen
Maximale continue warmteafgifte	$P_{max,c}$	(*) zie Tab. 1	kW	Elektronische sturing van de warmteopslag, met kamer- en/of buitentemperatuurfeedback	neen
Aanvullend elektriciteitsverbruik				Door een ventilator bijgestane warmteafgifte	neen
Bij nominale warmteafgifte	e_{lmax}	0,000	kW	Type warmteafgifte/sturing kamertemperatuur (selecteer één)	
Bij minimale warmteafgifte	e_{lmin}	0,000	kW	Entrapswarmteafgifte, geen sturing van de kamertemperatuur	neen
In stand-bymodus	e_{lsb}	0,00025	kW	Twee of meer handmatig in te stellen trappen, geen sturing van de kamertemperatuur	neen
				Met mechanische sturing van de kamertemperatuur door thermostaat	neen
				Met elektronische sturing van de kamertemperatuur	neen
				Elektronische sturing van de kamertemperatuur plus dag-tijdschakelaar	neen
				Elektronische sturing van de kamertemperatuur plus week-tijdschakelaar	ja
				Andere sturingsopties (meerdere selecties mogelijk)	
				Sturing van de kamertemperatuur, met aanwezigheidsdetectie	ja
				Sturing van de kamertemperatuur, met openraamdetectie	ja
				Met de optie van afstandsbediening	neen
				Met adaptieve sturing van de start	neen
				Met beperking van de werkingstijd	neen
				Met black-bulbsensor	neen
Contactgegevens	Ermete Giudici S.p.A. - via L. da Vinci 27 - 20090 Segrate (MI) Italia				

Tabel 1		KLIMA 7 KLIMA 7 AS	KLIMA 10	KLIMA 15	KLIMA 20
Warmteafgifte					
Nominale warmteafgifte	P_{nom}	0,750	1,000	1,500	2,000
Minimale warmteafgifte (indicatief)	P_{min}	0,075	0,113	0,150	0,188
Maximale continue warmteafgifte	$P_{max,c}$	0,750	1,000	1,500	2,000

INSTRUKCJA OBSŁUGI GRZEJNIKA KLIMA

Przed uruchomieniem grzejnika należy dokładnie zapoznać się z poniższymi instrukcjami, aby uniknąć uszkodzeń i niebezpiecznych sytuacji. Jakiegokolwiek użycie grzejnika inne niż określone w niniejszej instrukcji obsługi może spowodować pożar, porażenie prądem elektrycznym lub obrażenia i utratę gwarancji.

Gwarancja nie obejmuje wad, pogorszenia, utraty, uszkodzenia lub szkody spowodowane przez lub w wyniku, nie odpowiedniego użycia lub nadużycia tego grzejnika. Prawa dyktowane przez prawo państwowe, nie są pomijane. Żaden z warunków niniejszej gwarancji nie wyłącza jakichkolwiek warunków bądź gwarancji przewidzianych przepisami prawa krajowego, które nie mogą zostać uchylone ani zmienione.

Przed rozpoczęciem użytkowania usunąć opakowanie i sprawdzić integralność produktu. W przypadku wad lub uszkodzeń, nie próbuj naprawiać go samodzielnie, lecz skontaktuj się z sprzedawcą.

Nie pozwalaj dzieciom bawić się opakowaniem i chroni środowisko poprzez utylizację opakowania zgodnie z krajowymi przepisami dotyczącymi przetwarzania odpadów.

1. Dla własnego bezpieczeństwa

- ❑ Ten grzejnik jest przeznaczony do użytku domowego i nie został przystosowany do użytku komercyjnego/przemysłowego, w samochodach, na statkach lub samolotach.
- ❑ Produkt może być stosowany przez dzieci od 8 roku życia oraz osoby o ograniczonych zdolnościach fizycznych, czuciowych lub umysłowych, lub z niedostatecznym doświadczeniem i wiedzą, pod warunkiem że są one pod nadzorem osoby odpowiedzialnej za ich bezpieczeństwo lub zostały odpowiednio poinstruowane. Dzieci nie powinny bawić się produktem. Czyszczeniem i przeglądami użytkownika nie powinny się zajmować dzieci bez nadzoru.
- ❑ Dzieci poniżej 3 roku życia powinny być trzymane z dala od urządzenia chyba że są pod stałą opieką
- ❑ Dzieci pomiędzy 3 a 8 rokiem życia powinny tylko włączać i wyłączać urządzenie, oczywiście tylko wtedy, gdy umiejscowienie grzejnika na to pozwala, nie zapominając o ciągłym nadzorze i wytłumaczeniu jak korzystać z urządzenia w bezpieczny sposób. Dzieci pomiędzy 3 a 8 rokiem życia nie powinny wyciągać wtyczki z gniazda, operować termostatem, czyścić grzejnik lub wykonywać kontrole użytkowe urządzenia
- ❑ UWAGA – Niektóre elementy tego produktu mogą być bardzo gorące i mogą spowodować oparzenia. Szczególną uwagę trzeba poświęcić gdy w pobliżu znajdują się dzieci i osoby starsze.
- ❑ Upewnij się, że zasilanie sieciowe odpowiada nominalnej mocy: 230V AC, 50Hz.
- ❑ Nie wolno dopuścić, aby zwierzęta lub dzieci bawiły się lub dotykały urządzenie. Uwaga! Panel może być bardzo gorący podczas jego pracy (około 80°C/176°F);

- ❑ **OSTRZEŻENIE: W celu uniknięcia przegrzania, nie należy przykrywać grzejnika.** Nie kładź niczego na grzejniku i nie zastawiaj go podczas jego pracy. Jest to wyraźnie napisane na produkcie lub wskazuje na to symbol:



- ❑ Nie należy korzystać z produktu w pomieszczeniach nasyconych gazem wybuchowym, opary generowane przez rozpuszczalniki, farby lub łatwopalne opary / gaz.
- ❑ Jeśli kabel i / lub wtyczka są uszkodzone, nie należy ich naprawiać samemu, ale zwrócić produkt do serwisu technicznego lub autoryzowanego centrum naprawy aby naprawił go wyspecjalizowany pracownik w celu uniknięcia ryzyka uszkodzenia.
- ❑ Zawsze umieścić produkt tak, aby wtyczka była zawsze dostępna
- ❑ Nigdy nie umieszczać tego urządzenia bezpośrednio pod gniazdem zasilania.
- ❑ Nie umieszczaj żadnych rzeczy lub papieru wewnątrz grzejnika.

2. Twój produkt

- ❑ Po za grzejnikiem w pudełku znajduje się (rysunek 1):
 - 1 metalowy wspornik do montażu na ścianie (przymocowany do grzejnika);
 - 4 kołki rozporowe 8x50mm;
 - 4 wkręty metalowe 5x60mm;
- ❑ Skontaktuj się z sprzedawcą jeśli coś jest uszkodzone lub czegoś brakuje.

3. Bezpieczne pozycjonowanie grzejnika

- ❑ Produkt używać wyłącznie w pozycji poziomej;
- ❑ Produkt ten jest wyposażony w podwójny układ izolacji elektrycznej (klasa II) i w związku z tym nie wymaga uziemienia;
- ❑ Zawsze należy przestrzegać minimalnych odległości od ścian, mebli i / lub obiektów, jak pokazano na rysunku 2.
- ❑ Nie wolno instalować urządzenia na powierzchni wykonanej z **drewna lub tworzywa sztucznego**.
- ❑ Produkt ten jest odporny na zachłapania IP24. Dlatego może być stosowany w łazienkach lub innych obszarach w których występuje wilgoć pod warunkiem, że nie jest zainstalowany w strefie wanny lub prysznicza (Volume 1 rysunek 2).
- ❑ Nie można dopuścić do tego by ludzie w wannie lub pod prysznicem, mogli dosięgnąć do pokrętła regulacyjnego.

4. Montaż

- ❑ Zdejmij metalowy wspornik, który jest umieszczony z tyłu grzejnika, poprzez zwolnienie górnych zatrzasków a później dwóch dolnych zatrzasków jak to jest pokazane na rysunku 4.
- ❑ Postaw metalowy wspornik na ziemi i użyj go jako szablonu do odmierzenia dwóch dolnych dziur montażowych. (rysunek 5A)
- ❑ Unieś metalowy wspornik do góry tak aby dolne otwory zgadzały się z tymi odmierzonymi na ścianie i odmierz dwie górne dziury montażowe. (rysunek 5B)
- ❑ Wywierć wcześniej oznaczone cztery dziury i umieść w nich kołki rozporowe. (rysunek 6)
- ❑ Zawieś metalowy wspornik za pomocą czterech załączonych śrub. (rysunek 7)
- ❑ Umieść grzejnik zaczynając od dwóch dolnych zatrzasków, i później zatrasnij dwa górne na ich pozycje (rysunek 8)
- ❑ Jeżeli będzie potrzeba zdjęcia grzejnik z metalowego wspornika, rekomendujemy zdjęcie dolnych zatrzasków najpierw a później górnych.

5. Połączenia elektryczne

- ❑ Produkt musi być zasilany napięciem 230V AC 50Hz.
- ❑ Produkt musi być dostarczony z kablem i wtyczką lub kablem do instalacji. Jeśli produkt jest wyposażony w wtyczkę a jest montowany w Francji, podłącz go do sieci elektrycznej poprzez odcięcie wtyczki i połączenie go za pomocą kostki elektrycznej.
- ❑ Jeżeli produkt jest wyposażony w kabel do instalacji, należy go podłączyć do zasilania sieciowego za pomocą kabla 3-żyłowego (Brązowy = zasilanie, Niebieski = Neutralny, Czarny = przewód pilota) i skrzynki przyłączeniowej. **Jeśli nie korzystasz z funkcji pilota przewodowego, podłącz tylko fazę i neutralny: Produkt będzie działał poprawnie nawet bez programatora zewnętrznego.**
- ❑ W łazienkach, kuchniach i innych pomieszczeniach wilgotnych, zainstalować styki co najmniej 25 cm od podłogi.
- ❑ Podłączenie elektryczne do zasilania sieciowego musi również zawierać przełącznik 2-biegunowy z minimalnej przysłony styków 3mm. Jako priorytet, zawsze przestrzegać przepisów krajowych przy podłączaniu urządzenia.
- ❑ Zabronione jest podłączenie urządzenia do uziemienia. **NIE PODŁĄCZAĆ PRZEWODU PILOTA (CZARNY) DO UZIEMIENIA.**
- ❑ Jeżeli produkt jest zasilany przez wyłącznik różnicowy 30mA, upewnij się, że przewód sterujący jest również kontrolowany przez przełącznik różnicowy.

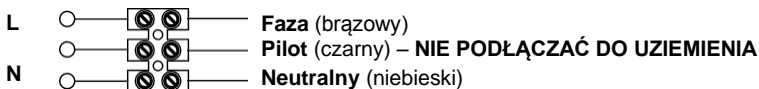

6. Korzystanie z produktu

6.1 Panel termostatu

- A – Włącznik / Wyłącznik
- B – Zmiana funkcji
- C – Specjalne funkcje
- D – Zwiększenie / Aktywacja
- E – Zmniejszenie / Dezaktywacja
- F – Wyświetlacz
- G – Główny przełącznik

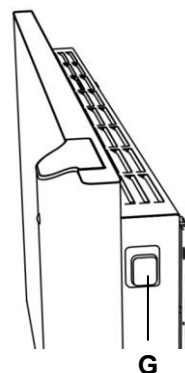
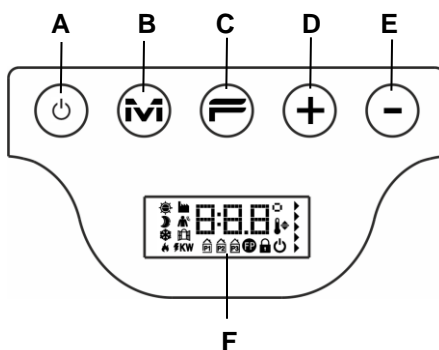



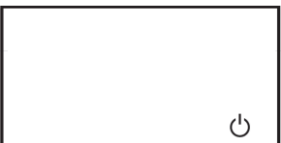

6.2 Obsługa

6.2.1 Uruchamianie ekranu

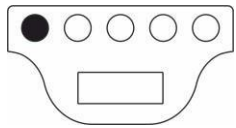

<p>Jeżeli ekran nie jest włączony naciśnij dowolny przycisk aby go podświetlić. Ekran podświetla się i pozostaje podświetlony przez 30 sekund po ostatnim naciśnięciu przycisku.</p>		<p>Jeżeli ekran jest wyłączony pierwsze naciśnięcie przycisku powoduje tylko podświetlenie ekranu bez aktywowania funkcji przypisanej do przycisku.</p>
--	---	---

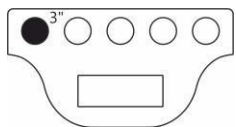



6.2.2 Włączanie/Wyłączanie grzejnika

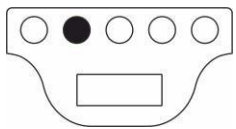

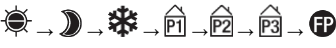



Zasilanie grzejnika sterowane jest przez wyłącznik główny (G) znajdujący się po prawej stronie grzejnika. Po wyłączeniu tego przełącznika następuje wyłączenie zasilania termostatu, co spowoduje utratę wszystkich zapisanych parametrów po około 30 minutach i przywrócenie ustawień domyślnych. Zalecamy używanie tego przełącznika tylko wtedy, gdy grzejnik nie będzie używany przez dłuższy czas. Zamiast tego możemy używać przycisku włączania / wyłączania (A) aby uniknąć utraty zapisanych ustawień.

<p>Kiedy grzejnik jest włączony za pomocą głównego przełącznika na boku urządzenia, ekran podświetli się i ikonka gotowości zaświeci się.</p>		
<p>Aby włączyć grzejnik naciśnij przycisk włącz/wyłącz</p> 		<p>Grzejnik zawsze włącza się na temperaturze komfortowej. Jeżeli grzejnik jest nowy bądź nie miał zasilania przez więcej niż 30 minut, temperatura komfortowa jest w standardzie ustawiona na 19oC.</p>
<p>Aby wyłączyć grzejnik przytrzymaj przycisk włącz/wyłącz przez co najmniej 3 sekundy.</p> 		<p>Wyłączając grzejnik za pomocą głównego wyłącznika na boku urządzenia na dłużej niż 30 minut spowoduje utratę wszystkich zapisanych danych (data, godzina, ustawione temperatury itp.)</p>

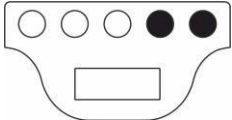

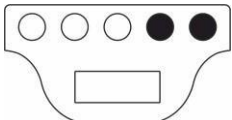

6.2.3 Wybieranie odpowiedniej funkcji

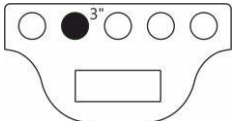
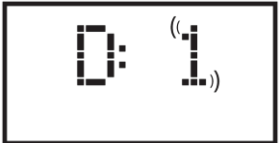
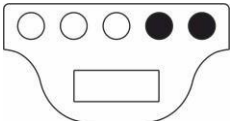
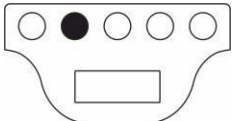

<p>Przycisk „M” pozwala na zmianę obecnej funkcji i wybranie pożądanej</p> 		<p>Funkcje aktywowane są w kolejności:</p>  <p>Gdy minie 30 sekund od ostatniego wciśnięcia przycisku „M” aktywacja funkcji zacznie się od początku, dla ułatwienia rozpoczyna się od ustawienia funkcji komfort.</p>
--	--	--

Ikona	Opis	Kiedy używać
	Komfort	Grzejnik pracuje by utrzymać ustawioną temperaturę komfortową.
	Eco	Gdy jesteś po za domem przez krótki okres czasu (od 2 do 48 godzin) lub gdy śpisz. Grzejnik pracuje z ustawioną temperaturą Eco w celu oszczędzania energii.
	Anti-freeze	Gdy jesteś po za domem przez długi czas (więcej niż 48 godzin). Temperatura jest automatycznie ustawiona na $7 \pm 3^{\circ}\text{C}$ i nie może zostać zmieniona.
	Program P1	Gdy chcesz korzystać z programu dostosowanego specjalnie dla tych co nie przebywają w domu. TEN PROGRAM MOŻNA RÓWNIEŻ MODYFIKOWAĆ WEDŁUG INSTRUKCJI ZAMIESZCZONEJ W PUNKCIE 6.2.6.

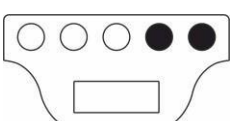
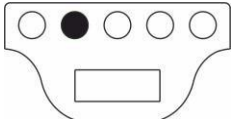
<p>Domyślnie temperatura Komfortowa Ustawiona jest na 19°C i może zostać zmieniona za pomocą przycisków „+” i „-”</p> 		<p>Jeżeli temperatura komfortowa zostanie ustawiona niższa niż temperatura Eco, ta ostatnia zostanie zmieniona automatycznie na temperaturę komfortową zmniejszoną o 0,5°C</p>
<p>Domyślnie temperatura Eco jest ustawiona na 15,5°C i może zostać zmieniona za pomocą przycisków „+” i „-”</p> 		<p>Rekomendowana różnica między temperaturami Komfortową a Eco to 3,5°C. Jeżeli zostanie ustawiona inna różnica niż sugerowana znaczek Eco zmieni się jak pokazano poniżej:</p>  <p>Maksymalna temperatura jaką można ustawić dla temperatury Eco jest równa temperaturze Komfort obniżonej o 0,5°C</p>
<p>Jeżeli temperatura otoczenia jest niższa niż temperatura zadana i wyświetlana, wskaźnik grzania włączy się na wyświetlaczu .</p>		

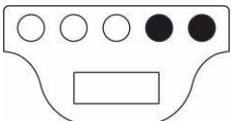
6.2.5 Ustawianie dnia i godziny

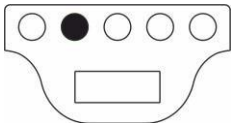
<p>Ustaw datę i godzinę aby korzystać z zapamiętanych programów, można tego dokonać poprzez przytrzymanie przez 3 sekundy przycisku „M”.</p> 		<p>Dzień zacznie migać, dzień tygodnia można teraz ustawić. (1- poniedziałek, 2- wtorek .. 7-niedziela), poprzez wciśnięcie przycisków „+” lub „-”</p> 
<p>Naciśnij przycisk „M” aby potwierdzić dzień i przejść do ustawiania godziny.</p> 		<p>Godzina zacznie migać, godzinę można teraz ustawić poprzez wciśnięcie przycisków „+” lub „-”</p> 
<p>Naciśnij przycisk „M” aby potwierdzić godzinę i przejść do ustawiania minut.</p> 		<p>Minuty zaczną migać, minuty można teraz ustawić poprzez wciśnięcie przycisków „+” lub „-”</p> 

<p>Naciśnij przycisk „M” aby potwierdzić minuty i zapisać ustawienia do pamięci.</p> 		<p>Termostat wróci do poprzedniego trybu który był uruchomiony przed ustawianiem daty i godziny.</p> <p>Gdy próbowałeś włączyć zapisany program bez ustawienia dnia i godziny, termostat przejdzie automatycznie w tryb ustawiania daty i godziny.</p>
--	--	--









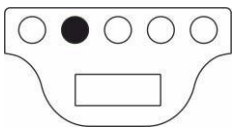

6.2.6 Modyfikowanie programu P1

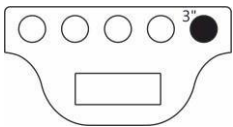

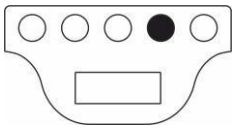

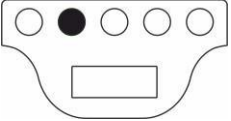
Program P1 może być zmieniany według uznania i potrzeb użytkownika. Modyfikacja P1 daje użytkownikowi możliwość na ustawienie pożądanej temperatury otoczenia, wybierając pomiędzy temperaturami Komfort, Eco i Anti-freeze na każdą godzinę w każdym dniu tygodnia.

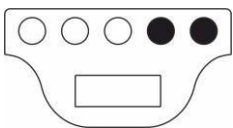
Aby ustawić temperaturę dla każdego trybu zjrzyj do rozdziału 6.2.4.

Każda godzina dnia pokazuje jaki jest ustawiony aktualny poziom temperatury dla programu P1. W przypadku, gdy grzejnik jest uruchomiony po raz pierwszy użyty jest profil pokazany w rozdziale 6.2.3.1.

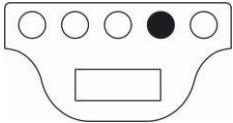

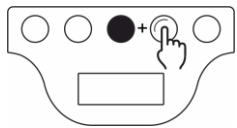
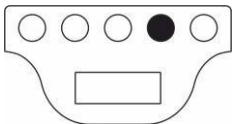

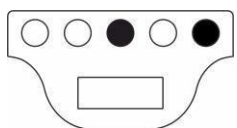





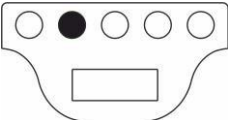

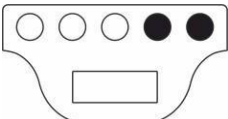

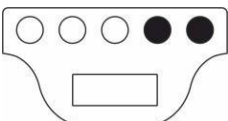

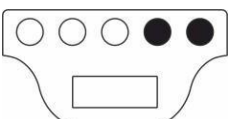
W celu wyświetlenia lub zmiany programu P1 postępuj zgodnie z poniższą instrukcją:

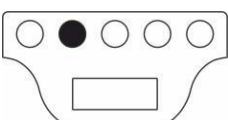

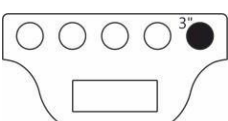

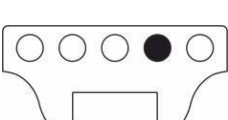

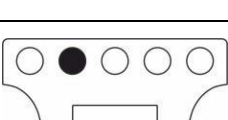

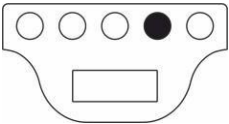

<p>Naciśnij „M” aby wybrać program P1</p> 		<p>W przypadku, gdy godzina nie została ustawiona (nowy produkt lub brak zasilania przez ponad 30 minut) uruchomiona zostanie procedura ustawiania godziny i daty (więcej informacji w rozdziale 6.2.5).</p>
<p>Aby wyświetlić program P1 przytrzymaj przycisk „-” przez 3 sekundy</p> 		<p>Pierwszy dzień jest do wglądu/modyfikacji jest teraz wyświetlany (1=poniedziałek).</p>
<p>Naciśnij przycisk „+” aby zobaczyć/modyfikować pierwszą godzinę</p> 		<p>Przyciśnij przycisk „M” aby wybrać pożądaną temperaturę pomiędzy Komfortową, Eco oraz Anti-freeze:</p>   <p>Wyświetlana temperatura po wybraniu odpowiedniej godziny w danym dniu jest to obecnie zapamiętana w programie P1.</p>
<p>Użyj „+” i „-” aby wybrać daną godzinę z dnia 1 i zobaczyć/zmodyfikować zapisany poziom temperatury dla każdej z nich.</p> 		<p>Godzina, która jest wyświetlana jest to godzina rozpoczęcia. Dla przykładu: H:23 jest wyświetlone, oznacza to że zmiana obejmuje przedział czasowy pomiędzy 23:00 a 00:00.</p>

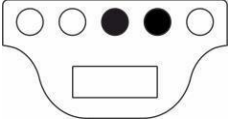
<p>Po ustawieniu temperatur dla wszystkich godzin w ciągu dnia 1, naciśnij przycisk „+” aby przejść do dnia 2</p> 		<p>Naciśnij przycisk „+” aby zobaczyć/zmodyfikować temperatury dla każdej godziny w dniu 2, jak opisano powyżej dla dnia 1.</p> <p>Możesz ustawić automatycznie ten sam program dnia 1 dla dnia 2 przez przytrzymanie przycisku „F” i naciśnięcie przycisku „+”</p>  <p>Uwaga: masz możliwość kopiowania i wklejania tego samego programu dniowego TYLKO WTEDY gdy wyświetlany jest dzień tygodnia który chcesz zmodyfikować (jak pokazano na obrazku), ALE NIE jak wyświetlana jest godzina.</p>
<p>Gdy ostatni dzień (dzień 7) zostanie ustawiony naciśnij przycisk „+” aby zakończyć programowanie.</p> 		<p>Napis END pojawi się na wyświetlaczu. Następne naciśnięcie przycisku „+” umożliwi ci zapisanie programu.</p>
<p>Napis OK wyświetli się na ekranie przez 5 sekund, potwierdzając że program został zapamiętany. System jest teraz przygotowany do pracy zgodnie z ustawionymi temperaturami według programu P1</p>		<p>Uwaga: Jest możliwe wyjście z programowania bez konieczności wyświetlania wszystkich godzin aż do dnia 7. Wystarczy tylko przytrzymać przycisk „F” i wcisnąć przycisk „-”</p> 
<p>Ponadto:</p> <ul style="list-style-type: none"> - Możesz przerwać wyświetlanie/zmianę w każdym momencie usuwając wszelkie zmiany które nie zostały zapisane, poprzez naciśnięcie przycisku „Włącz/Wyłącz”. - Przywrócenie ustawień domyślnych skasuje cały program P1 poprzednio stworzony (zajrzyj do rozdziału 6.3) - Jeżeli nie zostanie wciśnięty żaden przycisk przez 90 sekund podczas programowania, wszelkie zmiany zostaną cofnięte i ustawienia fabryczne zostaną załadowane. - Podczas programowania, elementy grzewcze zostaną automatycznie wyłączone i grzejnik nie będzie ogrzewał. 		

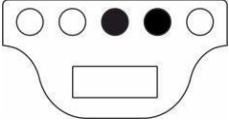

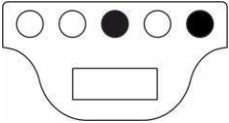
PRZYKŁAD: JAK ZAPROGRAMOWAĆ WŁASNY PROGRAM

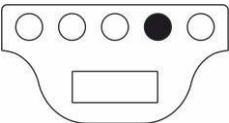





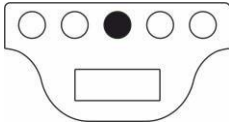

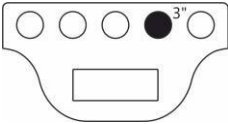
Zobaczymy jak zaprogramować nowy grzejnik i zmienić temperaturę ECO na KOMFORT jedną godzinę wcześniej (06:00 rano jest to ustawienie fabryczne) dla każdego dnia od Poniedziałku do Piątku.

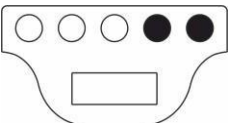
<p>Naciśnij „M” aby wybrać Program P1</p>		
<p>Ustaw aktualny dzień tygodnia (pierwsze użycie grzejnika) używając przycisków „+” lub „-”</p>		
<p>Naciśnij „M” i ustaw aktualną godzinę (pierwsze użycie grzejnika) używając przycisków „+” lub „-”</p>		
<p>Naciśnij „M” i ustaw minuty (pierwsze użycie grzejnika) używając przycisków „+” lub „-”</p>		
<p>Naciśnij „M” aby zakończyć ustawianie czasu. System automatycznie przejdzie do programu P1.</p>		
<p>Przytrzymaj „-” przez 3 sekundy, aby wyświetlić / zmodyfikować dnia 1.</p>		
<p>Naciskaj „+” aż zobaczysz H:05 na wyświetlaczu (to jest godzina którą chcemy zmienić z ECO na KOMFORT).</p>		
<p>Naciśnij „M” dwa razy aby zmienić temperaturę z ECO na KOMFORT.</p>		

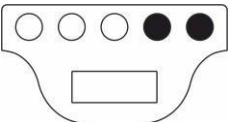
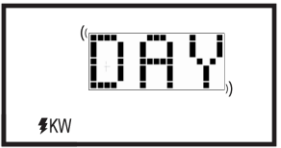
<p>Naciskaj „+” aż zobaczysz D:2 na wyświetlaczu (wtorek).</p>		
<p>Aby skopiować i wkleić ten sam program dnia 1 do dnia 2, przytrzymaj „F” i naciśnij „+”. System automatycznie skopiuje dane i przejdzie do dnia 3 (środa).</p>		
<p>Powtarzaj czynność opisaną powyżej aż zobaczysz D:6 na wyświetlaczu.</p>		
<p>Ponieważ nie chcemy zmieniać dnia 6 i 7, możemy wyjść z programowania poprzez przytrzymanie przycisku „F” i naciśnięcie „-”. Na wyświetlaczu pojawi się napis „END”.</p>		
<p>Naciśnij „+” aby potwierdzić zmiany. Na wyświetlaczu przez 5 sekund będzie migać napis „OK”</p>		

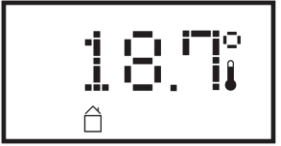
6.3 Funkcje specjalne

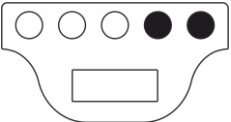
<p>Kilukrotne wciśnięcie przycisku „F” umożliwia zmianę różnych funkcji specjalnych dostępnych w kolejności</p>	 	<p>Aby opuścić menu funkcji specjalnych po prostu poczekaj 12 sekund lub wciśnij przycisk „M” aby wrócić do podstawowego menu.</p>
<p>Przywracanie ustawień fabrycznych</p>		<p>Aby przywrócić ustawienia grzejnika do ustawień fabrycznych przytrzymaj przez co najmniej 3 sekundy przycisk „+”</p> 

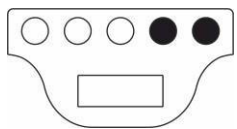

<p>Czujnik obecności (opcjonalnie)</p> <p>Funkcja ta umożliwia sterowanie grzejnikiem za pomocą wbudowanego czujnika ruchu, który wykrywa czy ktoś się znajduje w jego zasięgu i automatycznie reguluje poziom temperatury w celu zoptymalizowania komfortu i oszczędności energii. Więcej szczegółów w rozdziale 6.3.1.</p>		<p>Włączeniu bądź wyłączenie możliwe jest za pomocą przycisków „+” oraz „-”.</p>  <p>Włączenie jest sygnalizowane odpowiednią ikonką na ekranie (ON – dla włączonego, OFF – dla wyłączonego).</p>
<p>Czujnik otwartego okna</p> <p>Funkcja ta umożliwia wykrycie otwarcia okna i automatycznie włącza funkcję Anti-freeze. Więcej szczegółów w rozdziale 6.3.2</p>		<p>Włączeniu bądź wyłączenie możliwe jest za pomocą przycisków „+” oraz „-”.</p>  <p>Włączenie jest sygnalizowane odpowiednią ikonką na ekranie (ON – dla włączonego, OFF – dla wyłączonego)</p>
<p>Dzienne zużycie</p> <p>Funkcja ta umożliwia sprawdzenie ile energii zużył grzejnik w przeciągu 24 godzin.</p>		<p>Jeżeli wskaźnik zużycia miga oznacza to że zebrane dane są z okresu krótszego niż 24 godziny. Uwaga: Wyświetlane jest tylko przybliżone zużycie, które może być inne niż wskazywane przez specjalne mierniki odpowiednie do tego celu.</p>
<p>Tygodniowe zużycie</p> <p>Funkcja ta umożliwia sprawdzenie ile energii zużył grzejnik w przeciągu 7 dni.</p>		<p>Jeżeli wskaźnik zużycia miga oznacza to że zebrane dane są z okresu krótszego niż 7 dni. Uwaga: Wyświetlane jest tylko przybliżone zużycie, które może być inne niż wskazywane przez specjalne mierniki odpowiednie do tego celu.</p>
<p>Wyświetla temperaturę otoczenia</p>		<p>Wyświetlana jest temperatura otoczenia zmierzona przez urządzenie.</p>
<p>Korekta temperatury otoczenia</p> <p>Funkcja ta umożliwia edycję temperatury otoczenia mierzonej przez grzejnik w celu zarządzania mocą grzewczą. Jeżeli jest potrzeba korekcy w celu zniwelowania błędów odczytu z względu na bliskość źródła ciepła bądź z względu na prąd zimnego powietrza.</p>		<p>Wyświetlana jest migająca wartość korekcy która ma być wprowadzona. Aby edytować naciśnij przycisk „+” lub „-”.</p>  <p>Jeżeli dla przykładu temperatura otoczenia według grzejnika to 19,2°C a temperatura otoczenia zmierzona to 19,5°C popraw ją o +0,3°C.</p> <p> Zawsze odczekaj co najmniej 4 godziny, aż temperatura się wyrówna, przed jakąkolwiek zmianą.</p>

<p>Funkcja REM</p> <p>Głównym zadaniem funkcji jest możliwość sterowania grzejnikiem za pomocą zewnętrznego termostatu, termostatu gniazdkowego z kontrolą przez telefon oraz podobne urządzenia.</p> <p>Uwaga! zalecane włączenie funkcji REM na stałe nawet gdy nie używamy zewnętrznego termostatu. Więcej szczegółów w rozdziale 6.3.3</p>		<p>Zmiana pomiędzy włączonym (ON) a wyłączonym (OFF) za pomocą przycisków „+” i „-”.</p>  <p>Uwaga: Aktywacja funkcji nie jest sygnalizowana poprzez ikonkę na wyświetlaczu.</p>
--	---	---

6.3.1 Czujnik obecności (opcjonalnie)

Funkcja ta pozwala grzejnikowi wykrycie czy w zasięgu znajdują się ludzie czy nie, i automatycznie regulować poziomem temperatury, w celu uzyskania optymalnego komfortu i oszczędności energii.

Dzięki tej funkcji, która może zostać włączona tylko w trybie komfortowym, grzejnik cały czas monitoruje pomieszczenie i jeżeli nie zostanie wykryty żaden ruch, zmniejszona temperatura komfortowa zgodnie z poniższą tabelką:

Czas nieobecności	Zmniejszenie temperatury komfortowej	Ikonki wyświetlane na ekranie termostatu
60 minut	1,0°C	Symbole czujnika obecności i tryb komfortowego migają razem   (())
90 minut	2,0°C	
120 minut	3,5°C	
38 godzin	Anti-freeze 7±3°C	

Obniżenie temperatury odnosi się do temperatury komfortowej. Jeżeli grzejnik jest w trybie Eco lub Anti-freeze żadna zmiana w temperaturze która ma być utrzymana w pomieszczeniu nie zostanie zauważona.

Jeżeli ktoś zostanie wykryty w pomieszczeniu przez 10 kolejnych minut, temperatura automatycznie powróci do temperatury komfortowej bez żadnych obniżen. To samo się stanie gdy, podczas temperatury zadanej która została zmniejszona z uwagi na nie obecność ludzi w pomieszczeniu, naciśniemy przycisk „M”.

UWAGA:

Poprawne działanie tej funkcji może zależeć od pozycji w której zamontowany jest grzejnik w pomieszczeniu. Aby wybrać odpowiednie miejsce montażu pamiętaj że czujnik ruchu wykrywa w strefie w kształcie X i żaden obiekt nie może stać na jego drodze. Wykrywanie obecności jest bardziej efektywne, gdy osoby przechodzą przed grzejnikiem niż jak idą w jego stronę.

6.3.2 Czujnik otwartego okna

Funkcja ta umożliwia wykrycie otwartego okna i automatyczne przejście grzejnika w tryb Anti-freeze. Jeżeli zostanie wykryty nagły spadek temperatury podczas normalnej pracy zostanie uruchomiony tryb Anti-freeze w celu zmniejszenia strat energii. Na wyświetlaczu symbole okna oraz anti-freeze migają razem, podczas gdy symbol trybu pracy ustawiony przez użytkownika jest cały czas włączony

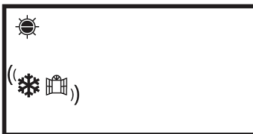

Przełączenie w tryb normalnej pracy nie następuje automatycznie, lecz musi być uruchomiony przez naciśnięcie przycisku „M”.

UWAGA:

Poprawne działanie tej funkcji może zależeć od pozycji grzejnika w pomieszczeniu, obecność prądów powietrznych, temperatury zewnętrznej i jak długo okno pozostaje otwarte.

6.3.3 Funkcja REM

UWAGA! Zalecamy włączenie tej funkcji zawsze gdy użytkujesz grzejnik Klima.

Funkcja ta umożliwia sterowanie grzejnikiem za pomocą zewnętrznego sterownika, gniazdkowego programatora sterowanego poprzez telefon, oraz podobnych urządzeń, ale także gdy nie stosujesz tych urządzeń. Funkcja ta odpowiada za ponowne uruchomienie urządzenia po zaniku napięcia w sieci. Kiedy ta funkcja zostanie uruchomiona i nastąpi przerwa w dostawie zasilania dłuższa niż 30 minut zamiast uruchomienia funkcji Stand-by (jak to się dzieje podczas normalnej pracy – bez uruchomienia tej funkcji) uruchomiony zostaje automatycznie tryb komfort. Temperatura komfortowa jest ustawiona taka jak przed przerwą w zasilaniu. Dodatkowe funkcje takie jak czujnik obecności oraz czujnik otwartego okna zostaną wyłączone. Oznacza to że grzejnik włączy się nawet jak nikogo nie będzie w pomieszczeniu.

6.4 Narzędzia

Zablokowanie klawiatury

Można zablokować przyciski sterowania grzejnikiem aby zapobiec przypadkowej lub niepożądaney zmianie. Aby przejść do funkcji blokady, przytrzymaj przycisk „F”

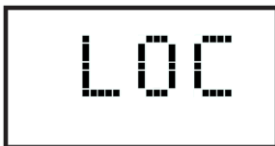
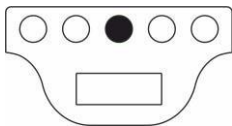

Gdy zostanie wyświetlony napis „LOC”

Przytrzymaj przycisk „F” i naciśnij „+” aby zablokować klawiaturę.

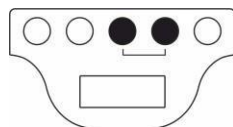

Uruchomienie jest wskazywane przez odpowiednią ikonkę która się zaświeci na wyświetlaczu 

Przytrzymaj przycisk „F” i naciśnij „-” aby odblokować klawiaturę.

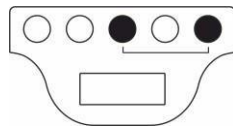

Gdy ta funkcja jest aktywowana, a zasilanie elektryczne powróci po czasie dłuższym niż 30 minut, tryb działania ustawiony w momencie zaniku napięcia będzie wznowiony. Jeżeli tryb działania to jeden z trzech programów P1,P2,P3 zostanie aktywowany tryb Anti-freeze, ponieważ wymagane jest ustawienie godziny i dnia tygodnia przed ponownym aktywowaniem programu.

7. W razie problemów

Problem	Rozwiązanie
Grzejnik nie włącza się.	Sprawdź czy zasilanie zostało podłączone i czy odpowiada nalepce na grzejniku (np. 230 VAC 50 Hz) i czy główny wyłącznik który znajduje się z prawej strony jest włączony (pozycja „I”).
Grzejnik nie grzeje.	Upewnij się że tryb pracy jest jak pożądaný i czy ustawiony program nie jest w przedziale czasowym, w którym jest ustawiony tryb anti-freeze. Jeżeli temperatura otoczenia jest większa niż ustawiona grzejnik się nie uruchomi. W razie wątpliwości ustaw tryb komfortowy i zwiększ temperaturę dużo wyższą niż temperatura otoczenia, aby sprawdzić czy grzejnik działa prawidłowo.
Grzejnik pozostaje gorący.	Sprawdź temperaturę czy nie została ustawiona zbyt wysoka lub czy nie ma żadnych prądów powietrznych przy grzejniku, lub ustawić korektę mierzonej temperatury otoczenia.
Grzejnik nie dogrzewa pomieszczenia.	Sprawdź czy nie została ustawiona za niska temperatura i czy grzejnik ogrzewa tylko pomieszczenie w którym jest zainstalowane (pozostaw zamknięte drzwi) i czy główne zasilanie jest odpowiednie.
Grzejnik grzeje w trybie Eco.	Grzejnik może dogrzewać aby osiągnąć/utrzymać temperaturę Eco. Nie jest to niezwykle zachowanie.
Przednia powierzchnia grzejnika jest bardzo gorąca	Jest to normalne że przednia powierzchnia jest gorąca podczas pracy. Maksymalna wartość mieści się w ograniczeniach ustanowionych w normach bezpieczeństwa. Jeżeli grzejnik jest zawsze bardzo gorący, może być za mały dla pomieszczenia które ogrzewa lub może być narażone na prądy powietrzne.
Temperatura w pomieszczeniu różni się od temperatury ustawionej na grzejniku.	Po odczekaniu co najmniej 4 godzin, aby temperatura się ustabilizowała w pomieszczeniu, można zrobić korektę pomiędzy temperaturą otoczenia a wskazywaną przez grzejnik. Aby to zrobić zobacz rozdział 6.3 Korekta temperatury otoczenia.
Grzejnik wydziela nie przyjemny zapach.	Jeżeli grzejnik jest nowy istnieje możliwość, że jak zacznie pracować pierwszy raz, może być wyczuwalny nie przyjemny zapach. Jest to pozostałość po procesie składania grzejnika. Grzejniki które już były używane mogą wydzielać nie przyjemny zapach jeżeli nie były używane przez dłuższy czas i/lub są używane w pomieszczeniach zanieczyszczonych o słabej jakości powietrza.

8. Konserwacja

- Ten produkt nie wymaga specjalnej konserwacji.
- Czyszczenia produktu, zwłaszcza panela przedniego, suchą szmatką raz na 6 miesięcy.
- Jeśli produkt wymaga naprawy, należy skontaktować się z autoryzowanym serwisem technicznym.
- W przypadku wymiany kabla zasilającego, użyj 2x1.00mm² lub 3x1.00mm² typu H05RR-F HAR, w zależności od wersji. Ta operacja, dla przewodów wyposażonych w wtyczkę, lub bez niej, muszą być wykonywane przez wykwalifikowany personel, a nie przez użytkownika końcowego, w celu uniknięcia uszkodzenia urządzenia oraz zagrożenia bezpieczeństwa osobistego.

9. Informacja prawna



Środowisko i recykling

Pomóż nam chronić środowisko naturalne przez utylizację opakowania zgodnie z obowiązującymi przepisami państwowymi co do zarządzania odpadami.

Recykling starych urządzeń

Urządzenia z tym znakiem nie mogą być wyrzucane jako odpady komunalne. Muszą być zbierane osobno i utylizowane zgodnie z normami lokalnymi.

PL - Informacje wymagane dla lokalnych elektrycznych ogrzewaczy pomieszczeń

Model: KLIMA					
Opis	Symbol	Wartość	Jednostka	Opis	Wartość
Moc grzewcza				Rodzaj wejścia ciepła, dla elektrycznych miejscowych ogrzewaczy pomieszczeń (wybierz jeden)	
Nominalna moc grzewcza	P_{nom}	Patrz Tabela 1	kW	Ręczna regulacja ładowania ciepła, z wbudowanym termostatem	nie
Minimalna moc grzewcza(orientacyjny)	P_{min}	Patrz Tabela 1	kW	Ręczna regulacja ładowania ciepła z odczytem temperatury pokojowej i/lub temperatury zewnętrznej	nie
Maksymalna ciągła moc grzewcza	$P_{max,c}$	Patrz Tabela 1	kW	Elektroniczna regulacja ładowania ciepła z odczytem temperatury pokojowej i/lub temperatury zewnętrznej	nie
Dodatkowe zużycie energii elektrycznej				Ciepło wspomagane wentylatorem	
Przy nominalnej mocy grzewczej	$e_{l_{max}}$	Patrz Tabela 1	kW	Rodzaj mocy grzewczej/kontroli temperatury pokojowej (wybierz jedną)	
Przy minimalnej mocy grzewczej	$e_{l_{min}}$	Patrz Tabela 1	kW	Jednostopniowe wytwarzanie ciepła i brak kontroli temperatury w pomieszczeniu	nie
W trybie czuwania (standby)	$e_{l_{SB}}$	0,00025	kW	Dwa lub więcej ręcznych etapów, brak kontroli temperatury w pomieszczeniu	nie
				Z ręczną regulacją temperatury pomieszczenia	nie
				Z elektroniczną regulacją temperatury pomieszczenia	nie
				Elektroniczna regulacja temperatury w pomieszczeniu plus zegar dzienny	nie
				Elektroniczna regulacja temperatury w pomieszczeniu plus zegar tygodniowy	tak
				Inne opcje sterowania (możliwe wielokrotne wybory)	
				Kontrola temperatury w pomieszczeniu, z wykrywaniem obecności	tak
				Kontrola temperatury w pomieszczeniu, z wykrywaniem otwartego okna	tak
				Z opcją kontroli odległości	nie
				Z adaptacyjną kontrolą startu	nie
				Z ograniczeniem czasu pracy	nie
				Z czujnikiem black bulb	nie
Dane producenta	Ermete Giudici S.p.A. - via L. da Vinci 27 - 20090 Segrate (MI) Italia				

Tabela 1		KLIMA 7 KLIMA 7 AS	KLIMA 10	KLIMA 15	KLIMA 20
Moc grzewcza					
Nominalna moc grzewcza	P_{nom}	0,750	1,000	1,500	2,000
Minimalna moc grzewcza(orientacyjnie)	P_{min}	0,075	0,113	0,150	0,188
Maksymalna ciągła moc grzewcza	$P_{max,c}$	0,750	1,000	1,500	2,000
Dodatkowe zużycie energii elektrycznej					
Przy nominalnej mocy grzewczej	$e_{l_{max}}$	0,000	0,000	0,000	0,000
Przy minimalnej mocy grzewczej	$e_{l_{min}}$	0,000	0,000	0,000	0,000

